



ENGINEERED FOR SUPERIOR PERFORMANCE

Compressed Air & Gas Systems

Catalogue





Engineered for
Superior Performance



AIRpipe specializes in solutions for compressed air and fluids distribution. Throughout the last 13 years we have continued to invest in R&D; taking into account market feedback and real-world conditions. Our products are engineered to be the most superior available - Advancing the compressed air & gas piping industry.

AIRpipe maintains a >300,000 sq ft campus for manufacturing, R&D, and logistics. We are committed to being your total system solutions provider.





Competitive Advantage



Superior Reliability & Longevity

- Highly-durable materials resistant to corrosion, vibration, thermal variation, and outdoor weather conditions.
- Metal clamshell connectors for all diameters are stronger and more durable versus polymer fittings.
- Unique grab ring design (20-50mm) and lugged ring (63-200mm) allows for zero risk of disconnection
- Patented active concentric seals provide leak-free performance. even in high vibration applications. Seal lifespan is double that of industry competitors.

Energy & Cost Savings

- The smooth interior design and high-flow connectors ensures a constant supply of clean air at a reduced pressure drop, resulting in significant energy savings.
- Guaranteed leak-free performance and superior longevity versus traditional pipe systems.

Quick & Easy Modular Installation

- Complete range of pipe, fittings and accessories works easily for new projects renovations & extensions.
- Requires no special tooling, welding, gluing, brazing, soldering, or thread cutting.
- Reusable, lightweight, and modular design allows for easy modifications.
- Quick drops can be added at any time to create new points of use.

Connection Technology

AIRpipe innovative modular technology enables rapid and easy assembly via quick connection of fittings to the aluminum pipe. This technology takes into account the specific requirement of each diameter to provide the user with a secure connection.

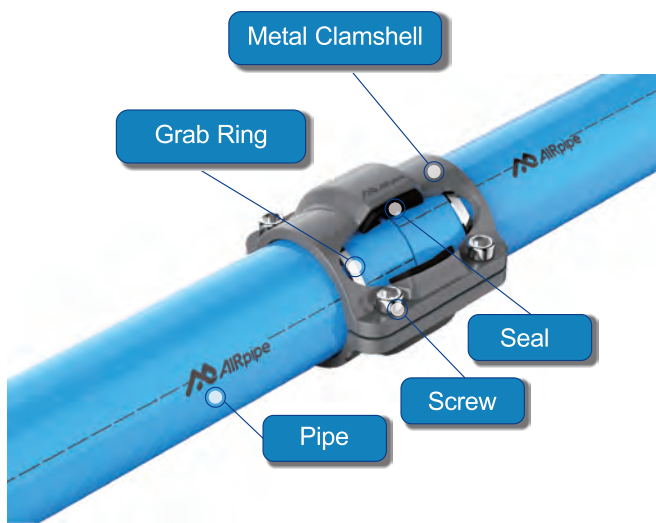

Grab Ring Clamping Style Connection

DN20 - DN50mm

- Metal clamshell union connector, quick install & reassembly.
- Grab ring with surface contact, no shrinking on inner diameter.
- Surface contact, active concentric sealing, leak free.
- Superior reliability & longevity.



Lugged Ring Clamping Style Connection

DN63 - DN200mm

- Metal clamshell union connector, quick install & reassembly.
- Convex ring, no shrinking on inner diameter.
- Surface contact, active concentric sealing, leak free.
- Superior reliability & longevity.

Technical Specifications

Suitable Fluids	Max. Working Pressure & Temp	Vacuum
<ul style="list-style-type: none"> Compressed air (dry, wet, lubricated) Vacuum Inert gases (including Argon, Helium, Nitrogen, CO2 mixes) <p>* Contact factory for process liquids and chemicals.</p>	<ul style="list-style-type: none"> Max. working pressure: 232 psi. (Max. working pressure for DN200 is 188 psi.) -4°F to +176°F <p>* Higher temperature seal options are available.</p>	<ul style="list-style-type: none"> Vacuum: .3 inches of mercury (absolute vacuum)
Resistance to		Recyclability
<ul style="list-style-type: none"> Corrosion Aggressive environments Mechanical shocks Thermal variations Ultraviolet (U.V.) Compressor oil carry over (mineral/ synthetic) 		<ul style="list-style-type: none"> 100% recyclable

Linear Branch (Straight Run) - System Sizing Chart										
Flow Rate (SCFM)	Equivalent Length (feet)									
	50'	150'	300'	400'	500'	1000'	2000'	3000'	4000'	5000'
10	3/4"	3/4"	3/4"	3/4"	3/4"	3/4"	3/4"	1"	1"	1"
25	3/4"	3/4"	3/4"	3/4"	1"	1"	1-1/2"	1-1/2"	1-1/2"	1-1/2"
50	1"	1"	1"	1"	1-1/2"	1-1/2"	1-1/2"	1-1/2"	1-1/2"	2"
75	1"	1"	1-1/2"	1-1/2"	1-1/2"	1-1/2"	1-1/2"	2"	2"	2"
100	1-1/2"	1-1/2"	1-1/2"	1-1/2"	1-1/2"	1-1/2"	2"	2"	2-1/2"	2-1/2"
150	1-1/2"	1-1/2"	1-1/2"	1-1/2"	1-1/2"	1-1/2"	2-1/2"	2-1/2"	2-1/2"	2-1/2"
250	2"	2"	2"	2"	2"	2-1/2"	2-1/2"	2-1/2"	3"	3"
500	2-1/2"	2-1/2"	2-1/2"	2-1/2"	2-1/2"	2-1/2"	3"	3"	4"	4"
750	2-1/2"	2-1/2"	3"	3"	3"	3"	4"	4"	4"	6"
900	3"	3"	3"	3"	3"	3"	4"	4"	6"	6"
1000	3"	3"	3"	3"	3"	4"	4"	6"	6"	6"

Looped Installation - System Sizing Chart										
Flow Rate (SCFM)	Equivalent Length (feet)									
	50'	150'	300'	400'	500'	1000'	2000'	3000'	4000'	5000'
10	3/4"	3/4"	3/4"	3/4"	3/4"	3/4"	3/4"	3/4"	3/4"	3/4"
25	3/4"	3/4"	3/4"	3/4"	3/4"	3/4"	1"	1"	1"	1"
50	3/4"	3/4"	3/4"	3/4"	1"	1"	1"	1-1/2"	1-1/2"	1-1/2"
75	3/4"	3/4"	1"	1"	1"	1"	1-1/2"	1-1/2"	1-1/2"	1-1/2"
100	1"	1"	1"	1"	1"	1-1/2"	1-1/2"	1-1/2"	1-1/2"	2"
150	1"	1"	1-1/2"	1-1/2"	1-1/2"	1-1/2"	1-1/2"	1-1/2"	2"	2"
250	1-1/2"	1-1/2"	1-1/2"	1-1/2"	1-1/2"	2"	2"	2"	2-1/2"	2-1/2"
500	2"	2"	2"	2"	2"	2-1/2"	2-1/2"	2-1/2"	2-1/2"	3"
750	2"	2"	2-1/2"	2-1/2"	2-1/2"	2-1/2"	2-1/2"	2-1/2"	3"	3"
900	2-1/2"	2-1/2"	2-1/2"	2-1/2"	2-1/2"	2-1/2"	3"	3"	3"	4"
1000	2-1/2"	2-1/2"	2-1/2"	2-1/2"	2-1/2"	3"	3"	3"	4"	4"

• Both Charts Consider 100 psi, and less than a 5% Pressure Drop.

* Note: visit www.airpipeusa.com to use our interactive sizing tool.



Warranty and Certifications



10 Year Limited Warranty

- AIRpipe USA warrants its products to be free of defects in Material and workmanship for a period of ten years from the date of product purchase. No other warranties, express or implied are made by AIRpipe USA. This limitation explicitly excludes any implied warranty of merchantability or fitness for a particular purpose. The sole remedy for breach of this warranty of material and workmanship or for negligence in manufacture or design is limited to replacement or repair, at the sole digression of AIRpipe USA. In no event shall AIRpipe USA, it's parent, and sister companies be liable for indirect, special, incidental or consequential damages of any kind. No allowance will be made for repairs made by the purchaser.
- AIRpipe USA does not warrant the design, assembly or installation of the system, but only the components listed within AIRpipe USA's price list. AIRpipe USA is not responsible for improper assembly, installation, or for any modifications of the product

The warranty is void upon

- (a) Failure to follow assembly or installation guidelines;
- (b) Alteration, misuse or abuse of, or damage to the products;
- (b) Operation beyond the design range, excessive pressure, stress, or mishandling in any way;
- (d) Use other than for the intended purpose or in a manner other than specified by AIRpipe USA.

Engineering standards:

- ASME B31.1 & B31.3
- UL94HB
- UL94V-2
- TUV
- CE & EN
- PED 2014/68/EU
- TS
- ASTM B241, EN755-8, GB/T4437.1-2000, JIS H4080

Certifications and Compliances:

- ISO 9001 version 2000
- ISO 14001 version 2004
- ISO 8573-1 version 2010
- ASME, UL, TUV, CRN, CE, EN and TS

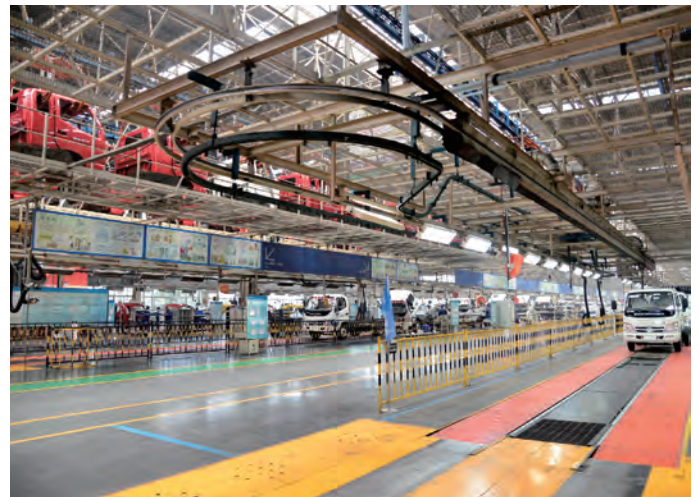

CONTENT

Rigid Aluminum Pipe		07
Connectors		08
Quick Drop Connectors		14
Wall Brackets & Valved Connectors		15
Flanged Connectors		17
Flexible Hose		19
Fixtures & Accessories		20
Tools		23
Installing AIRpipe		25



Rigid Aluminum Pipe

- Clean air certified (ISO 8573-1)
- Optimum flow performance
- Lightweight
- High quality powder coated exterior
- Extruded aluminum
- Suitable for Compressed air, oil-free or lubricated vacuum, and inert gasses (Nitrogen, Argon, Helium)
- Max. working pressure: 232 psi
Max. working pressure for DN200 is 188 psi
- Vacuum: .3 inches of mercury (absolute pressure)
- Working temperature: -4 up to +176

Blue / Grey / Green

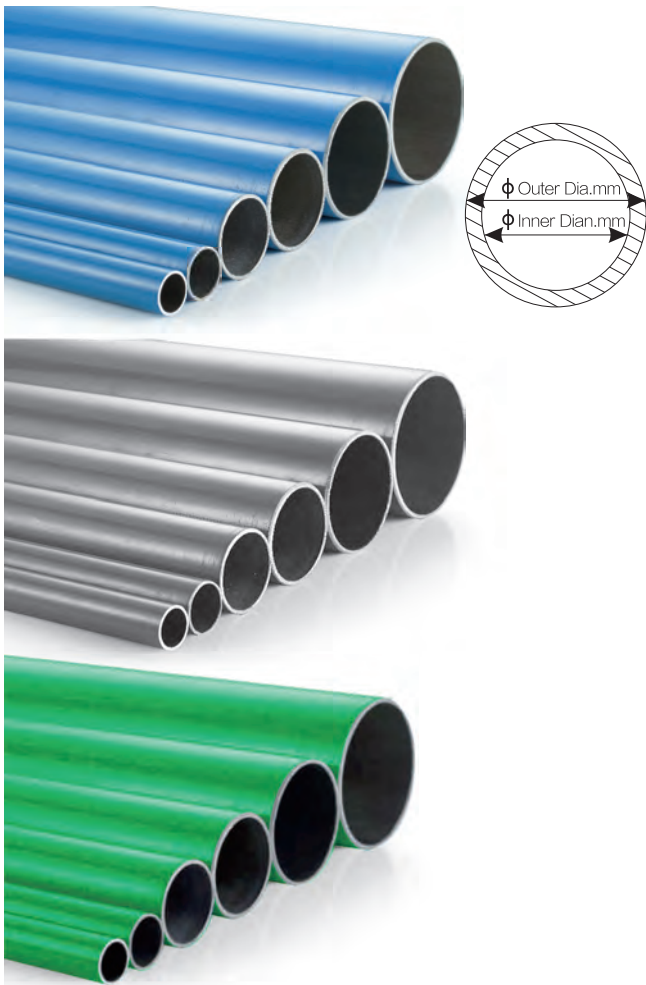

*Other colors, please consult us.

AIRpipe	Nominal Diameter (in)	OD(mm)	ID(mm)	L(ft)
1000	¾"	20.1	17.5	19
2000	1"	25.1	22.5	19
4000	1-½"	40.1	36.5	19
5000	2"	50.1	45.7	19
6000	2-½"	67.6	63	19
7000	3"	84.8	80.0	19
8000	4"	101.8	96.8	19
9000	6"	153	147.5	19
A000	8"	205	197.8	19
1062	¾"	20.1	17.5	19
2062	1"	25.1	22.5	19
4062	1-½"	40.1	36.5	19
5062	2"	50.1	45.7	19
6062	2-½"	67.6	63	19
7062	3"	84.8	80.0	19
8062	4"	101.8	96.8	19
9062	6"	153	147.5	19
A062	8"	205	197.8	19
1061	¾"	20.1	17.5	19
2061	1"	25.1	22.5	19
4061	1-½"	40.1	36.5	19
5061	2"	50.1	45.7	19
6061	2-½"	67.6	63	19
7061	3"	84.8	80.0	19
8061	4"	101.8	96.8	19
9061	6"	153	147.5	19
A061	8"	205	197.8	19

Connectors

- Quick connection
- Superior reliability & longevity
- Designed for extreme environments

- Modular and reusable
- 100% recyclable and non-flammable materials (UL94-HB Standard)
- Viton seals for high temperature applications are available

Pipe to Pipe Connector

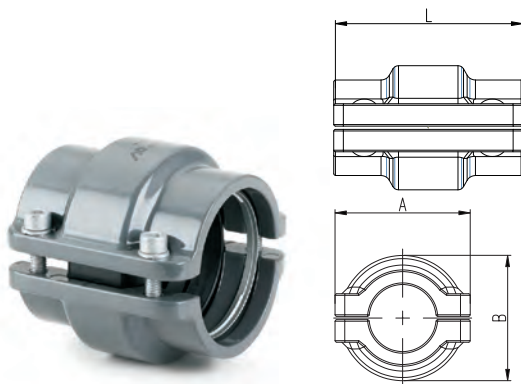

<i>AIRpipe</i>	Nominal Diameter	L	A	B
1002	20	59	36	41
2002	25	59	42	44
4002	40	78	69	60
5002	50	79	80	74

Pipe to Pipe Connector

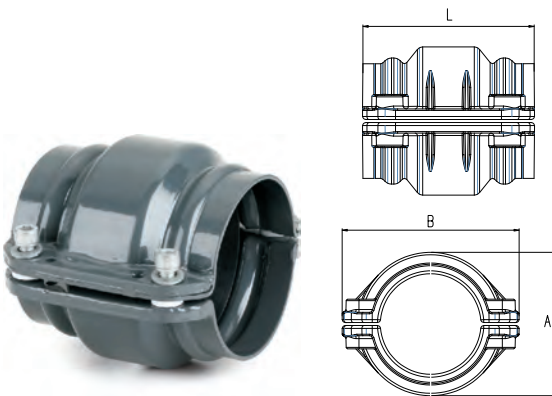

<i>AIRpipe</i>	Nominal Diameter	L	A	B
6002	63	114	98	121
7002	80	114	115	137
8002	100	146	128	157
9002	150	146	188	224
A002	200	135	240	265

Equal 90° Elbow

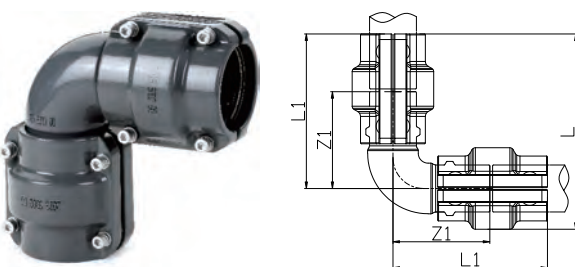

<i>AIRpipe</i>	Nominal Diameter	L1	L	Z1
1003	20	80	100	61
2003	25	83	105	67
4003	40	109	139	91
5003	50	115	152	101

Equal 90° Elbow

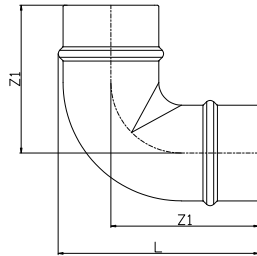

AIRpipe	Nominal Diameter	L	Z1
6003	63	143	105
7003	80	156	110
8003	100	194	140
9003	150	265	185
A003	200	315	207.5

* Supplied with (2) union connectors.

Equal 45° Elbow

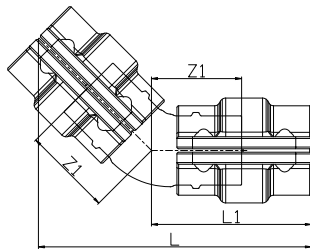

AIRpipe	Nominal Diameter	L	L1	Z1
1004	20	118	70	39
2004	25	119	71	40
4004	40	159	92	52
5004	50	162	95	54

Equal 45° Elbow

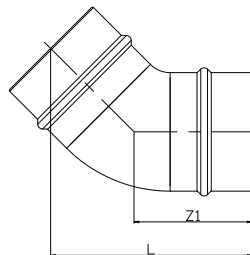

AIRpipe	Nominal Diameter	L	Z1
6004	63	144	84
7004	80	145	85
8004	100	179	105
9004	150	215	126
A004	200	231	135

* Supplied with (2) union connectors.

Equal Tee

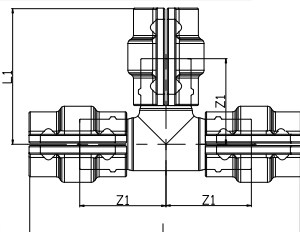

AIRpipe	Nominal Diameter	L	L1	Z1
1005	20	160	80	49
2005	25	166	83	52
4005	40	218	109	69
5005	50	230	115	74

Equal Tee

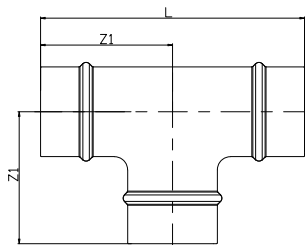

AIRpipe	Nominal Diameter	L	Z1
6005	63	200	100
7005	80	220	110
8005	100	262	131
9005	150	332	170
A005	200	375	187.5

* Supplied with (3) union connectors.

Reducing Tee

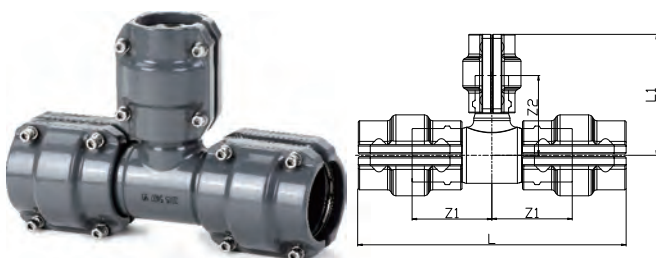

AIRpipe	Nominal Diameter	L	Z1	Z2	L1
2107	25x20	160	50	51	80
4207	40x25	200	61	60	90
5207	50x25	220	70	71	101
5407	50x40	220	70	74	114

Reducing Tee

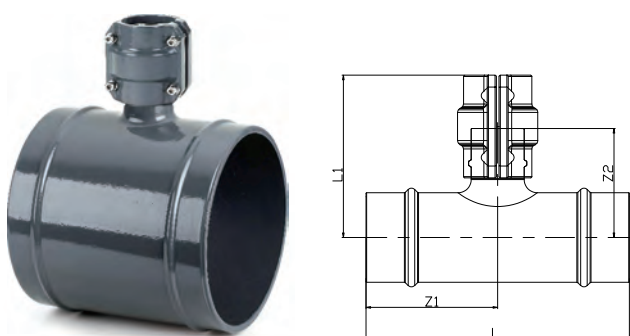

AIRpipe	Nominal Diameter	L	Z1	L1	Z2
6407	63x40	200	100	122	83
6507	63x50	200	100	123	83
7407	80x40	190	100	132	92
7507	80x50	220	106	133	92
8507	100x50	226	118	141	100

* Supplied with (2) union connectors.

Reducing Tee

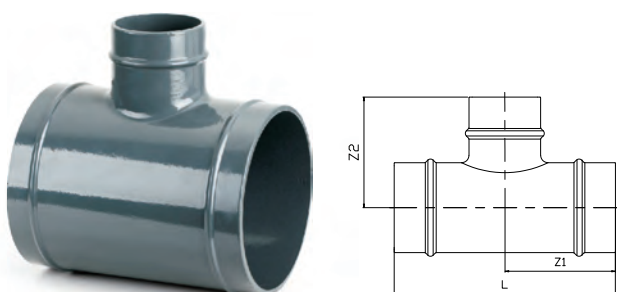

AIRpipe	Nominal Diameter	L	Z1	Z2
7507	80x63	210	105	105
8607	100x63	236	118	118
8707	100x80	246	123	121
9607	150x63	242	121	150
9707	150x80	226	131	147
9807	150x100	272	136	162
A607	200x63	240	120	170
A707	200x80	256	128	171
A807	200x100	276	138	182
A907	200x150	344	172	182

* Supplied with (2) union connectors.

Equal Lateral Wye

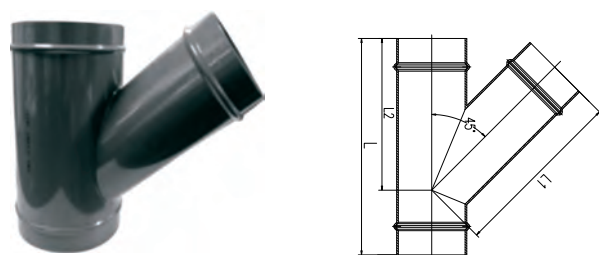

AIRpipe	Nominal Diameter	L	L1	L2
6009	63	238	184	163
7009	80	262	211	184
8009	100	305	246	213
9009	150	385	340	280
A009	200	459	400	347

* Supplied with (3) union connectors.

Lateral Reducing Wye

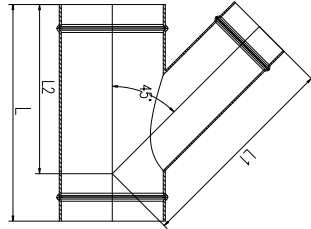

AIRpipe	Nominal Diameter	L	L1	L2
8712	100x80	282	226	202
9712	150x80	292	276	235
9812	150x100	312	300	244
A812	200x100	320	339	275
A912	200x150	394	377	312

* Supplied with (3) union connectors.

Reducing Pipe to Pipe Connector

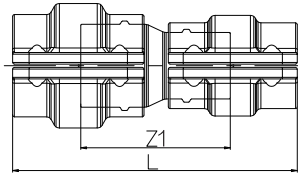

AIRpipe	Nominal Diameter	L	Z1
2121	25x20	130	67
4221	40x25	156	84
5221	50x25	160	86
5421	50x40	172	91

Reducing Pipe to Pipe Connector

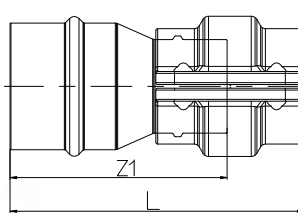

AIRpipe	Nominal Diameter	L	Z1
6421	63x40	156	116
6521	63x50	157	117
7521	80x50	158	117

* Supplied with (1) union connector.

Reducing Pipe to Pipe Connector

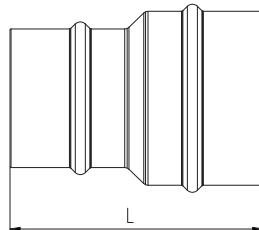

AIRpipe	Nominal Diameter	L
7621	80x63	126
8621	100x63	152
8721	100x80	141
9721	150x80	155
9821	150x100	172
A921	200x150	170

* Supplied with (2) union connectors.

End Cap

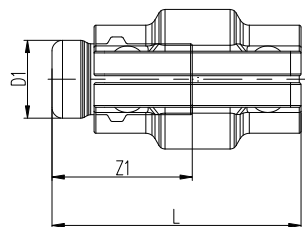

AIRpipe	Nominal Diameter	L	D1	Z1
1006	20	70	22	40
2006	25	70	27	40
4006	40	90	42	49
5006	50	91	52	50

End Cap

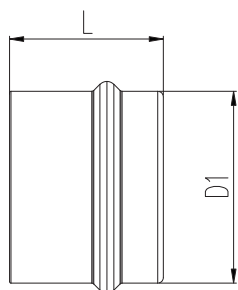

AIRpipe	Nominal Diameter	L	D1
6006	63	54	68
7006	80	55	85.4
8006	100	70	101.8
9006	150	70	153
A006	200	70	205

* Supplied with (1) union connector.

Male Threaded Elbow

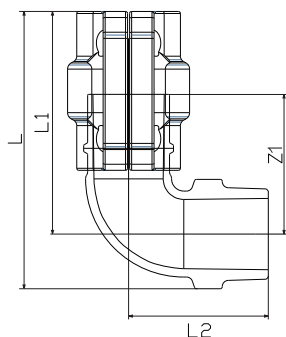

AIRpipe	DN	L	L1	L2	NPT	Z1
1015	20	95	79	49	1/2"	49
1115	20	95	79	49	3/4"	49
2015	25	102	82	52	1/2"	52
2215	25	102	82	52	1"	52
4415	40	141	109	109	1-1/2"	69
5515	50	151	114	114	2"	74

* Note: Suitable for connecting to air compressors, dryers, and filters.

Female Threaded Elbow

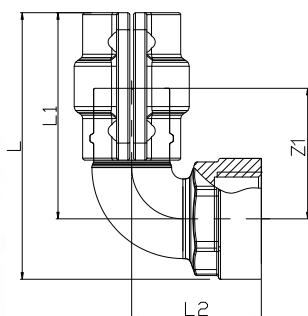

AIRpipe	DN	L	L1	L2	NPT	Z1
1013	20	95	79	49	1/2"	49
1113	20	95	79	49	3/4"	49
2013	25	102	82	52	1/2"	52
2213	25	102	82	52	1"	52
4413	40	141	109	69	1-1/2"	69
5513	50	151	114	74	2"	74

* Note: Suitable for connecting to air compressors, dryers, and filters.

Female Threaded Adapter

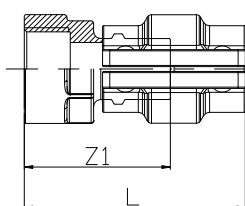

AIRpipe	Nominal Diameter	L	NPT	Z1
1019	20	88	1/2"	57
1119	20	88	3/4"	58
2019	25	90	1/2"	59
2219	25	90	1"	60
4419	40	119	1-1/2"	78
5519	50	120	2"	79

Female Threaded Adapter

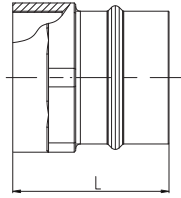

AIRpipe	Nominal Diameter	L	NPT
6619	63	93	2-1/2"
7719	80	100	3"

* Supplied with (1) union connector.

Male Threaded Adapter

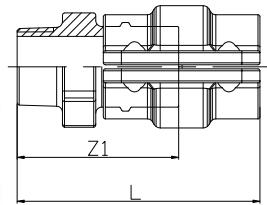

AIRpipe	Nominal Diameter	L	Z1	NPT
1017	20	90	59	1/2"
1117	20	91	60	3/4"
2017	25	92	60	1/2"
2117	25	93	60	3/4"
2217	25	93	62	1"
4217	40	119	78	1"
4317	40	122	81	1-1/4"
4417	40	122	81	1-1/2"
4517	40	122	81	2"
5417	50	122	81	1-1/2"
5517	50	126	85	2"

Male Threaded Adapter

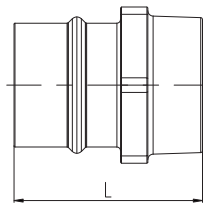

AIRpipe	Nominal Diameter	L	NPT
6517	63	98	2"
6617	63	103	2-1/2"
7617	80	107	2-1/2"
7717	80	110	3"

* Supplied with (1) union connector.

Female Threaded Straight Quick Drop

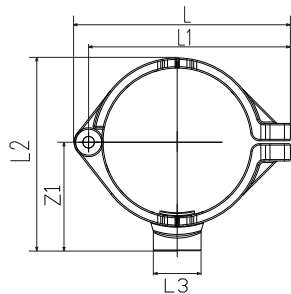

AIRpipe	Nominal Diameter	L	L1	L2	L3	NPT	Z1	Hole Saw Bit Size
5099	50x1/2"	84	76	76	33	1/2"	46	25
5199	50x3/4"	84	76	76	33	3/4"	46	25
6099	63x1/2"	113	103	97	57	1/2"	33	25
6199	63x3/4"	113	103	97	57	3/4"	33	25
7099	80x1/2"	131	121	112	64	1/2"	33	25
7199	80x3/4"	131	121	112	64	3/4"	33	25
8099	100x1/2"	150	142	133	75	1/2"	33	25
8199	100x3/4"	150	142	133	75	3/4"	33	25
9099	150x1/2"	202	192	183	99	1/2"	33	25
9199	150x3/4"	202	192	183	99	3/4"	33	25
A099	200x1/2"	256		247	134	1/2"	33	25
A199	200x3/4"	256		247	134	3/4"	33	25

* DN50-DN150 are manufactured with hinges.

Quick Drop Connectors

- All-aluminum body
- Alignment stub design for quick installation

- Optimum flow
- Captivated seal

Note: the hole saw bit sizing chart is on page 27

Quick Drop

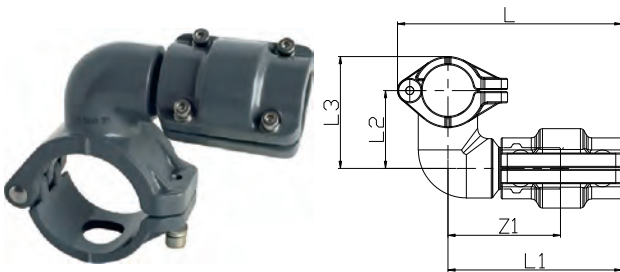

AIRpipe	Nominal Diameter	L	L1	Z1	L2	L3	Hole Saw Bit Size
2110	25x20	110	85	55	38	55	16
2210	25x25	110	85	55	38	55	16
4110	40x20	125	91	61	45	70	22
4210	40x25	125	91	61	45	70	22
5110	50x20	129	89	59	54	84	25
5210	50x25	129	89	59	54	84	25
6110	63x20	152	89	59	71	112	25
6210	63x25	152	89	59	71	112	25
7110	80x20	158	89	59	77	127	25
7210	80x25	158	89	59	77	127	25
8110	100x20	154	83	53	97	154	25
8210	100x25	154	83	53	97	154	25
9110	150x20	202	82	52	123	204	25
9210	150x25	202	82	53	123	204	25
A210	200x25	256	84	55	149	267	25

Female Threaded Quick Drop

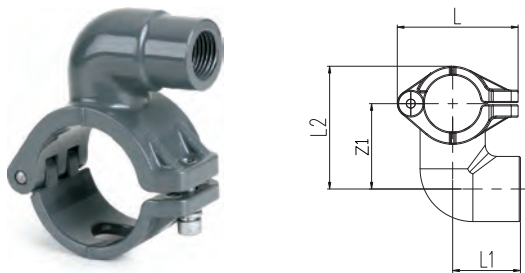

AIRpipe	DN x NPT	L	L1	Z1	L2	Hole Saw Bit Size
2011	25x1/2"	54	30	38	55	16
4011	40x1/2"	72	42	45	70	22
4111	40x3/4"	72	42	45	70	22
5011	50x1/2"	83	46	54	84	25
5111	50x3/4"	83	47	54	84	25

Female Threaded Quick Drop

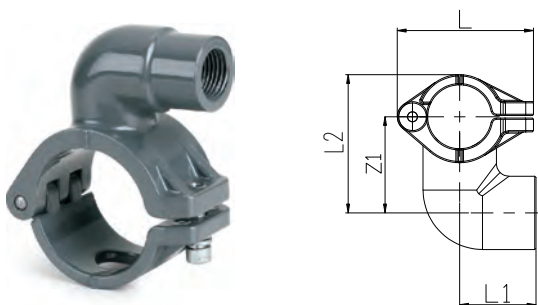

AIRpipe	DN x NPT	L	L1	Z1	L2	Hole Saw Bit Size
6011	63x1/2"	126	65	75	112	25
6111	63x3/4"	126	78	75	112	25
7011	80x1/2"	138	65	80	127	25
7111	80x3/4"	138	78	80	127	25
8011	100x1/2"	170	54	95	150	25
9011	150x1/2"	219	55	120	201	25

Straight Quick Drop

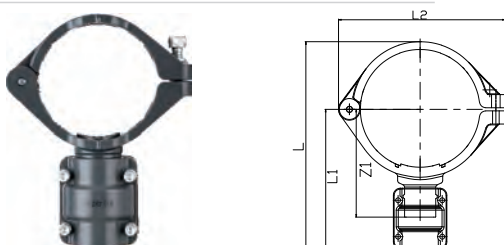

AIRpipe	Nominal Diameter	L	L1	L2	Z1	Hole Saw Bit Size
8410	100x40	204	134	162	104	38
9410	150x40	267	180	215	150	51
9510	150x50	255	181	215	151	51
A410	200x40	329	206	269	176	51
A510	200x50	330	207	269	177	51

Wall Brackets & Valved Connectors

- Quick connection
- Available for BSP/NPT thread, flange and plug-in connection type

- High-flow design ensure optimal performance
- Nickel-plated brass

Quick Connect Valve

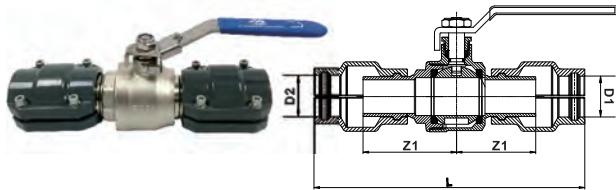

AIRpipe (NPT)	D1	D2	L	Z1
1052	20	20	165	52
2052	25	25	169	55
4052	40	40	232	76
5052	50	50	242	80
6052	63	63	206	96

* Material of Valve Body: Brass.
* Locking Handle.

One-port Female Wall Bracket

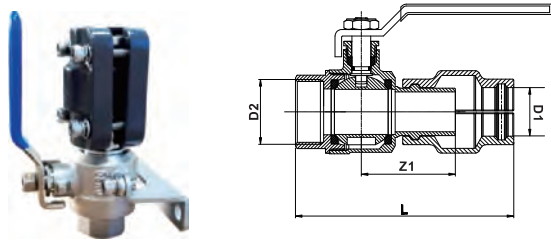

AIRpipe (NPT)	D1	D2	L	Z1
1252	20	½"	118	52
2252	25	1"	115	55
2452	25	½"	215	76
4452	40	1-½"	154	80
5552	50	2"	165	76
6552	63	2-½"	160	96

* Material of Valve Body: Brass.
* Includes Mounting Plate and Hardware.
* Locking Handle.

Two-port Female Wall Bracket

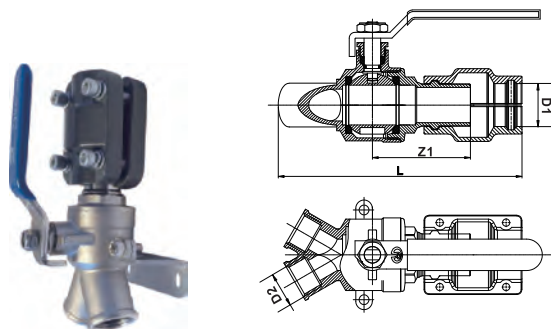

AIRpipe (NPT)	D1	D2	L	Z1
1152	20	½"	133	52
2152	25	½"	144	52

* Material of Valve Body: Brass.
* Includes Mounting Plate and Hardware.
* Locking Handle.

Male Threaded Quick Connect Valve

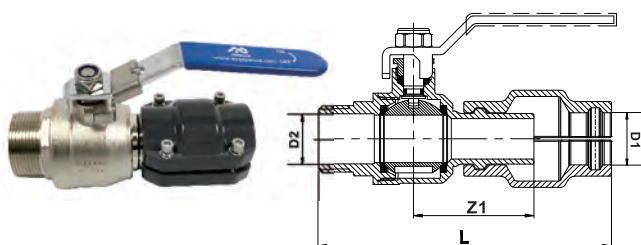

AIRpipe (NPT)	D1	D2	L	Z1
1352	20	¾"	116	52
2352	25	1"	122	55
4352	40	1-½"	163	76
5352	50	2"	177	80
6352	63	2-½"	173	96

* Material of Valve Body: Brass.
* Locking Handle.

Angled Two-Port Female Wall Bracket



AIRpipe (NPT)	D1	Connector
1552	20	75° Two ports, 1/2"
2552	25	75° Two ports, 1/2"

- * Material of Valve Body: Brass.
- * Includes Mounting Plate and Hardware.
- * Locking Handle.

One & Two Port Angled Wall Brackets



AIRpipe (NPT)	D1	Connector
1123	20	45° One port, 1/2"
2123	25	45° One port, 1/2"
1023	20	45° Two ports, 1/2"
2023	25	45° Two ports, 1/2"

- * Material of Body: Aluminium.
- * Includes a 1/4" venting valve.

Threaded Ball Valve



AIRpipe (NPT)	D1	D2	L	Thread
0073	1/2"	1/2"	53	Female
0173	3/4"	3/4"	58	Female
1073	1/2"	1/2"	60	Male
1173	3/4"	3/4"	65	Male
0273	1/2"	1/2"	53	Male* Female
1273	3/4"	3/4"	59	Male* Female
2073	1"	1"	70	Female
4073	1-1/2"	1-1/2"	90	Female
5073	2"	2"	103	Female

- * Material of Valve Body: Brass.
- * Locking Handle.

Butterfly Valve Pre-Assembled



AIRpipe (NPT)	Nominal Diameter	L	Material of valve
6051	63	188	Cast Iron
7051	80	210	Cast Iron
8051	100	236	Cast Iron
9051	150	256	Cast Iron
A051	200	278	Cast Iron
6151	63	188	Stainless Steel
7151	80	210	Stainless Steel
8151	100	236	Stainless Steel
9151	150	256	Stainless Steel
A151	200	278	Stainless Steel

- * Locking Handle.

* Lever Handle: 6051, 7051, 6151, 7151

* Wheel Handle: 8051, 9051, A051, 8151, 9151, A151

Flange Connectors

ANSI Aluminum Flange

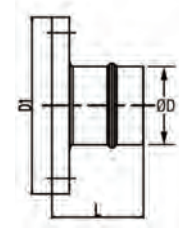
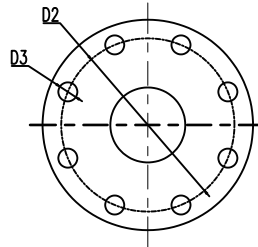

AIRpipe	Pipe End Size	Flange Size (in)	Bolt Size	L	D1	D2	D3
6170	2-1/2"	2-1/2"	M16	85	180	139.7	18
7170	3"	3"	M16	82	190	152.4	18
8170	4"	4"	M16	92	230	190.5	18
9170	6"	6"	M20	100	280	241.3	22
A170	8"	8"	M20	109	345	298.5	22

* Includes bolts and gasket.

* Supplied with one union connector.

ANSI Aluminum Reducing Flange

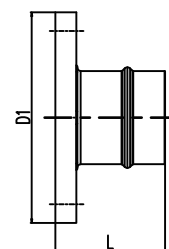
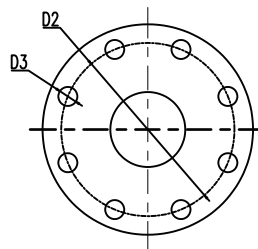

AIRpipe	Pipe End Size	Flange Size (in)	Bolt Size	L	D1	D2	D3
7671	2-1/2"	3"	M16	85	190	152.4	18
8671	2-1/2"	4"	M16	87	230	190.5	18
6771	3"	2-1/2"	M16	87	180	139.7	18
8771	3"	4"	M16	84	230	190.5	18
0771	3"	4-1/2"	M16	84	255	215.9	22
7871	4"	3"	M16	92	190	152.4	18
0871	4"	4-1/2"	M20	92	255	215.9	22
9871	4"	6"	M20	92	280	241.3	18
0971	6"	4-1/2"	M20	100	255	215.9	22

* Includes bolts and gasket.

* Supplied with one union connector.

ANSI Female Threaded Flange

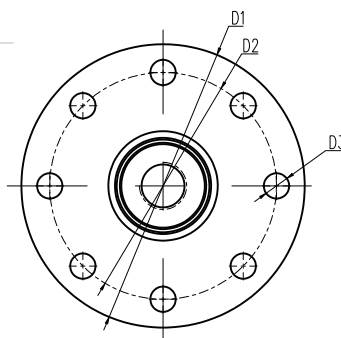

AIRpipe	Nominal Diameter	Female Thread	Bolt Size	D1	D2	D3	H
2270	25	1"	M14	110	79.4	14	16
4470	40	1-1/2"	M14	125	98.4	18	21
5570	50	2"	M16	150	120.7	18	24
6270	63	1"	M16	180	139.7	18	27
6470	63	1-1/2"	M16	180	139.7	18	27
6570	63	2"	M16	180	139.7	18	27
7270	80	1"	M16	190	152.4	18	29
7470	80	1-1/2"	M16	190	152.4	18	29
7570	80	2"	M16	190	152.4	18	29
7670	80	2-1/2"	M16	190	152.4	18	29
8470	100	1-1/2"	M16	230	190.5	18	32
8570	100	2"	M16	230	190.5	18	32
8670	100	2-1/2"	M16	230	190.5	18	32
9470	150	1-1/2"	M20	280	241.3	22	38
9570	150	2"	M20	280	241.3	22	38
9670	150	2-1/2"	M20	280	241.3	22	38
9770	150	3"	M20	280	241.3	22	38

* Above flange material: Stainless steel.

AIRpipe	Nominal Diameter	Female Thread	Bolt Size	D1	D2	D3	H
2279	25	1"	M14	110	79.4	14	16
4479	40	1-1/2"	M14	125	98.4	18	21
5579	50	2"	M16	150	120.7	18	24
6279	63	1"	M16	180	139.7	18	27
6479	63	1-1/2"	M16	180	139.7	18	27
6579	63	2"	M16	180	139.7	18	27
7279	80	1"	M16	190	152.4	18	29
7479	80	1-1/2"	M16	190	152.4	18	29
7579	80	2"	M16	190	152.4	18	29
7679	80	2-1/2"	M16	190	152.4	18	29
8479	100	1-1/2"	M16	230	190.5	18	32
8579	100	2"	M16	230	190.5	18	32
9279	150	1"	M20	230	190.5	18	32
9479	150	1-1/2"	M20	280	241.3	22	38
9579	150	2"	M20	280	241.3	22	38
9679	150	2-1/2"	M20	280	241.3	22	38
9779	150	3"	M20	280	241.3	22	38

* Above flange material: Carbon steel.

* Includes 1 gasket and 4 bolts(7cm) for DN25/DN40/DN50/DN63

* Includes 1 gasket and 8 bolts(7cm) for DN80/DN100/DN150

Flexible Hose

- Suitable for compressor & equipment outlets to absorb vibration
- Bypass obstacles
- Allows for expansion and contraction of loops
- Resistant to mineral and synthetic lubricated oils

Flexible Hoses

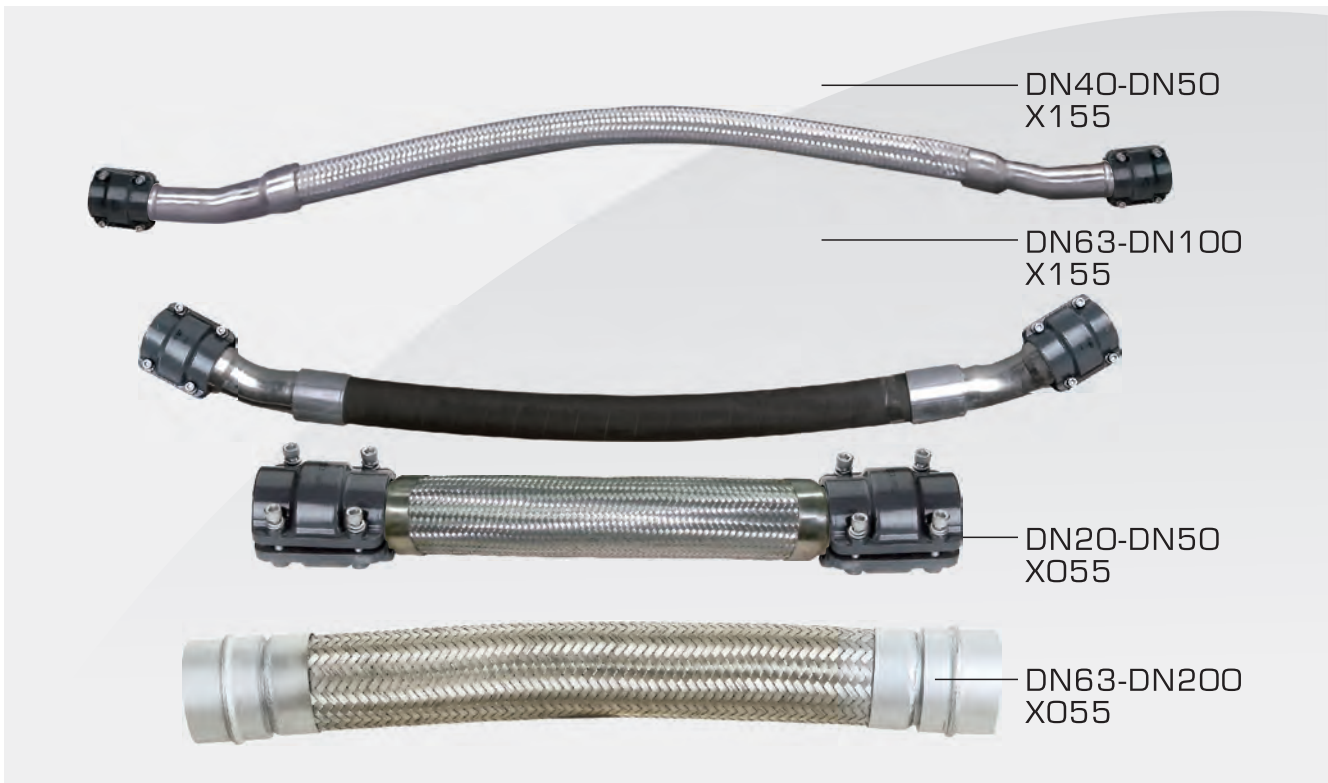

AIRpipe	Nominal Diameter	D	L1	L2	Remark
4155	40	40.1	39.37	47.24	SS304 material, 30°
5155	50	50.1	43.31	53.15	
6155	63	67.6	47.24	53.15	
7155	80	84.8	66.93	72.83	Rubber material, 30°
8155	100	101.8	66.93	74.80	
1055	20	20.1	19.69	22.44	SS304 material Straight connection
2055	25	25.1	19.69	22.44	
4055	40	40.1	19.69	23.62	
5055	50	50.1	19.69	23.62	
6055	63	67.6	19.69	25.59	SS304 material Straight connection
7055	80	84.8	19.69	25.59	
8055	100	101.8	19.69	25.98	
9055	150	153	35.43	41.89	
A055	200	205	55.12	61.18	

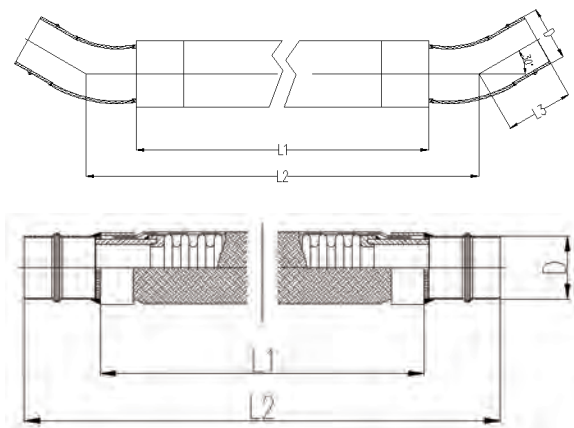

Fixtures & Accessories

- Suitable for various pipe systems
- Used for a variety of installation methods, eg: wall, beam, roof, channel, rod, cable, etc, vertically or horizontally

- Non-flammable
- Designed to work best with AIRpipe system

Fixture Clip

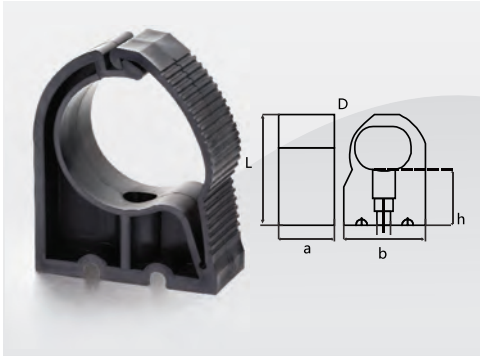

AIRpipe	D	I	L	H	a	b
1022	20	3/8"	56	30	30	31
2022	25	3/8"	60	27.5	30	38
4022	40	3/8"	101	50	40	60
5022	50	3/8"	108	45	40	75
6022	63	3/8"	118	38.5	40	94
7022	80	3/8"	172	71	50	119
8022	100	3/8"	209	83	60	162

* 3/8"-16 threaded rod port.

Clip Spacer

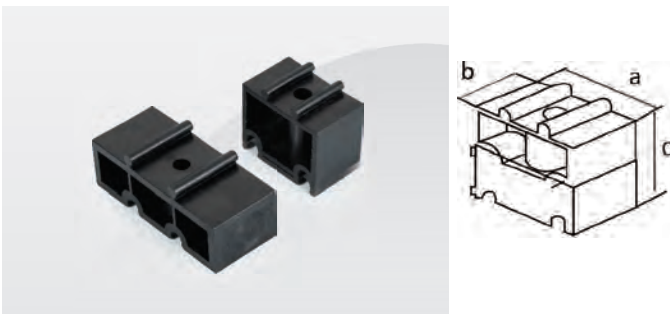

AIRpipe	Compatible sizes	a	b	c
0027	20-25	30	49	34.4
0127	40-63	30	94	29.4

* Spacer clip 0027 is used to create a level plane for 3/4" or 1" diameters transitioning to 1-1/2", 2", or 2-1/2".

* Spacer clip 0127 is used to create a level plane for 1-1/2", 2", or 2-1/2" diameters transitioning to 3" or 4".

Unistrut Nut

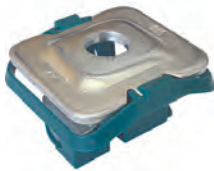

AIRpipe	Applicable Diameter
0227	3/8" - 16 threaded Rod Port

Fixture Clip (Steel)



AIRpipe	Diameter
4122	40
5122	50
6122	63
7122	80
8122	100
9122	150
A122	200

* 3/8"-16 threaded rod port.

Threaded Adapter

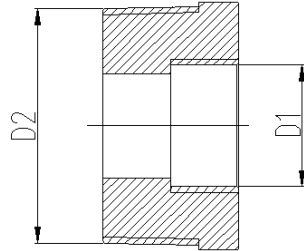

AIRpipe (NPT)	Female D1	Male D2	Material
4950	1"	1-½"	Aluminum
5050	1"	2"	Aluminum
5450	1-½"	2"	Aluminum
6250	1"	2-½"	Aluminum
6550	2"	2-½"	Aluminum
7250	1"	3"	Aluminum
7450	1-½"	3"	Aluminum
7550	2"	3"	Aluminum
7650	2-½"	3"	Aluminum
8250	½"	¾"	Aluminum
8350	½"	¼"	Aluminum
8550	½"	1"	Aluminum
8750	¾"	½"	Aluminum

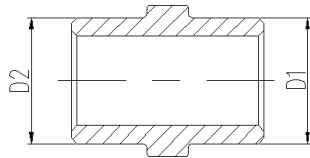

AIRpipe (NPT)	D1	D2	Material
8150	1"	¾"	Aluminum
8450	½"	¼"	Aluminum
8650	¾"	½"	Aluminum

Threaded Adapter

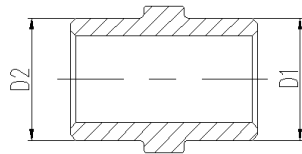

AIRpipe (NPT)	D1	D2	Material
0031	½"	½"	Aluminum
1131	¾"	¾"	Aluminum
2231	1"	1"	Aluminum
4431	1-½"	1-½"	Aluminum
5531	2"	2"	Aluminum

* Note: Used for the connection between two filters.

Manifolds



<i>AIRpipe</i> (NPT)	D	Connection Port
0283	Male 1/2"	Two-port manifold
0383	Male 1/2"	Three-port manifold
0783	Male 1/2"	Four-port manifold

* Inlets and outlets are 1/2".

* Couplers are available through AIRpipe.

Universal Quick Couplers



<i>AIRpipe</i>	Applicable Diameter
1484	1/4" Universal Quick Coupler (ISO 6150B/ Automotive), 1/2" Male NPT
3884	3/8" Universal Quick Coupler (ISO 6150B/ Automotive), 1/2" Male NPT
4284	1/4" Male NPT Automotive Nipple
8284	3/8" Male NPT Automotive Nipple
4184	1/4" Male NPT Industrial (ISO B) Nipple
8184	3/8" Male NPT Industrial (ISO B) Nipple

Demo Case



<i>AIRpipe</i>	H	L	I
0146	200	270	190

Tools

Tool Bag (PN 0045)



- * Contains all tooling for DN20-50, along with hex and hole saw bits for all diameters and quick drop fittings.
- * For DN80 and DN100 pipe installation, 0140 and 0844 are needed.
- * For DN150 and DN200 pipe installation, 0340 and 0844 are needed.

AIRpipe	Component Description
0141	20 mm to 50 mm (¾" to 2") Pipe Deburrer
0042	20 mm to 200 mm (¾" to 82") Hole Deburrer
0643	Drill Arbor & Pilot Bits for 38 and 51 mm Hole Saw Bits
0543	51 mm Hole Saw Bit
0443	38 mm Hole Saw Bit
0343	25 mm Hole Saw Bit
0243	Drill Arbor & Pilot Bits for 16,22,and 25 mm Hole Saw Bits
0843	22 mm Hole Saw Bit
0743	16 mm Hole Saw Bit
0040	20 mm to 63mm (¾" to 2-½") Pipe Cutter
PM	Permanent Marker
0044	Pipe Insertion Depth Gauge
4 mm	4 mm Hex Bit (2" in length) for Drill
5 mm	5 mm Hex Bit (2" in length) for Drill
6 mm	6 mm Hex Bit (2" in length) for Drill
8 mm	8 mm Hex Bit (2" in length) for Drill
0046	Logoed Canvas Bag

* Items are available for individual purchase.

Electric Pipe Cutter



AIRpipe	Applicable Diameter
0344	DN63 - DN200

Aluminum Pipe Cutter



AIRpipe	L	H	Applicable Diameter
0040	220	40	DN63 - DN200
0140	240	40	DN40 - DN100

Aluminum Pipe Deburrer



AIRpipe	L	H	Applicable Diameter
0141	90	70	DN20 - DN50

Hole Deburrer



<i>AIRpipe</i>	L	Applicable Diameter
0042	160	DN20 - DN200

Drill Arbor & Pilot Bit



<i>AIRpipe</i>	L	Applicable Drill	Applicable Diameter
0243	110	16-25	DN25 - DN100
0643	110	38-51	DN150 - DN200

Hole Saw Bit



<i>AIRpipe</i>	L	Hole Saw Bit Size	Applicable Diameter
0743	50	16	DN25
0843	50	22	DN40
0343	50	25	DN50 - DN200
0443	50	38	DN100
0543	50	51	DN150 - DN200

Portable Lugging Machine



<i>AIRpipe</i>	Applicable Diameter	Remark
0844	DN63 - DN200	Contains every jaw set



Installing AIRpipe

General

General

- Prior to the installation of a AIRpipe compressed air distribution system, the installer should ensure that the installation area complies with any regulations applicable to areas exposed to explosive hazards (in particular the effect of static electricity) in a silo area). AIRpipe should be installed downstream of the compressed air receiver, or after the dryer. Flexible AIRpipe hose can be installed at the start of the system in order to eliminate any sources of vibration and to facilitate maintenance operations. When maintaining or modifying an AIRpipe system, the relevant section should be vented prior to the commencement of any work. Installers should use only AIRpipe components and accessories, in particular AIRpipe pipe clips and fixture clamps. The technical properties of the AIRpipe components, as described in the AIRpipe catalog, must be respected.
- AIRpipe aluminum pipe is supplied ready for use. No particular preparation (cutting, deburring, chamfering, etc.) is required.
- Thanks to the rigidity of AIRpipe aluminum pipe, temperature-related expansion / contraction is reduced to a minimum. The AIRpipe system retains its straightness, and hence its performance, over time (reduction of pressure drop caused by surface friction).
- AIRpipe aluminum pipe is calibrated and fits perfectly with all AIRpipe components.

Component assembly

- AIRpipe components are provided with assembly instructions for their correct use - simply follow the methods and recommendations stated in this document.

Expansion / contraction

- Expansion and contraction of the system should be calculated prior to installation. The system designer and installer should calculate the elongation or retraction of each AIRpipe line according to the recommendations in this installation guide .

Situations to avoid

- AIRpipe pipe should be protected from mechanical impact, particularly if exposed to collision with fork-lift trucks or when sited in an environment with moving overhead loads. Similarly, rotation of the pipe and pipe supports should be avoided. AIRpipe pipe must not be welded. Flexible AIRpipe hoses should be used in accordance with the recommendations of the installation guidelines.
 - installation within a solid mass (concrete, foam, etc).
 - the hanging of any external equipment to AIRpipe pipe.
 - the use of AIRpipe for grounding, or as a support for electrical equipment.
 - exposure to chemicals that are incompatible with AIRpipe components (please contact us for further details)..

Best practices to maintain an optimized AIRpipe System

- Design, installation, and maintenance should be performed in accordance with reasonable engineering knowledge and practice with involving piping systems.
- Maintain high-quality air levels within your system.
- To avoid pressure drops within your system, minimize pipe diameter reductions.
- Properly size your system to allow for optimal flow and efficiency.

Measuring Pipe Insertion Depth

- When installing pipe diameters ¾" to 2", use the insertion depth gauge (part number 0044) to place an insertion depth mark on the pipe.

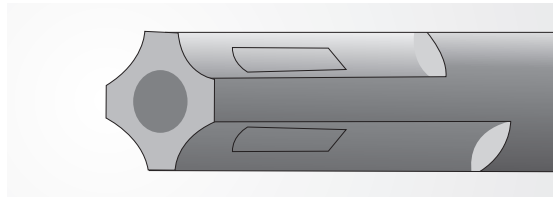

Drilling indicator

- An identifying layline is imprinted on each length of pipe that may be used as an alignment guide when installing quick drop connectors.

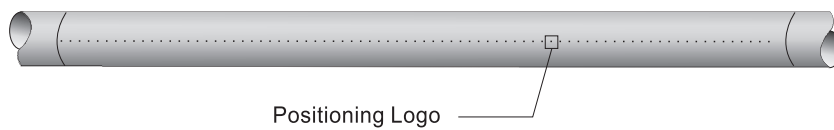

Cutting the pipe

- Rotate the corresponding pipe cutter around the pipe while gently tightening the wheel.

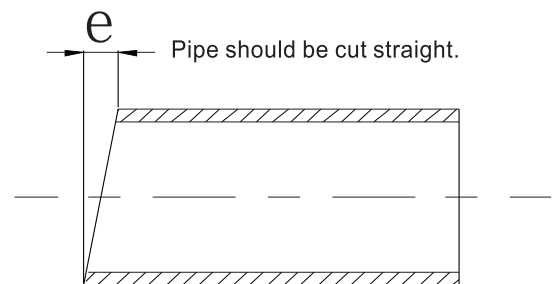

Use part number 0040 for pipe diameters ¾" to 2-½".
Use part number 0140 for pipe diameters 1-½" to 4".

Nominal Diameter	Cutting slope of pipe and allowable deviation (e)
20 - 80	1.0
100 - 150	1.4
200	2.0

Superior Reliability!

Quick and Easy Installation



Sizing Chart for Quick Drops

Pilot Bit	Hole Saw	DN (MM)	Quick Drops (PN)					
0243	0743	Φ16	2110	2210	2011			
0243	0843	Φ22	4110	4210	4011	4111		
0243	0343	Φ25	5110	5210	6110	6210	7110	7210
			8110	8210	9110	9210	A210	
			5011	5111	6011	6111	7011	7111
			8011	9011				
			5099	6099	7099	8099	9099	A099
			5199	6199	7199	8199	9199	A199
0643	0443	Φ38	8410					
0643	0543	Φ51	9410	9510	A410	A510		



Insertion Depth S For DN20-DN50 Connector

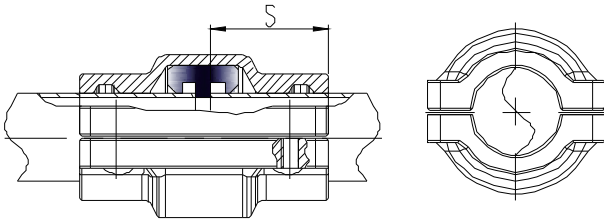

DN	Insertion depth S (IN)
20	1.14"
25	1.14"
40	1.53"
50	1.53"

• "S" denotes the insertion depth of the pipe into the connector.

Installation Guide for DN20-DN50

01 Mark the pipe with a marker pen as shown below.

02 Insert the marked pipe into the connector.

04 A portion of the marked lines should remain visible after the pipe is inserted into the connector.

03 Bring the second pipe to the connector and slide up to the marked insertion depth.

05 Tighten the pre-fitted screws. Flush the clamshell halves together to complete assembly.

06 Tighten the screws in an "X" pattern. To disassemble, perform the same operation in reverse order.

Deburr The Outer and Inner Edges Before Installation

- Use 0141 for DN20-DN50 to deburr the outer edges and also deburr the inner end.
- Use a file for DN63-DN200 to chamfer the outer edges; Make sure of a deburring tool to deburr the inside of the pipe end.



Installation Guide for DN63-DN200

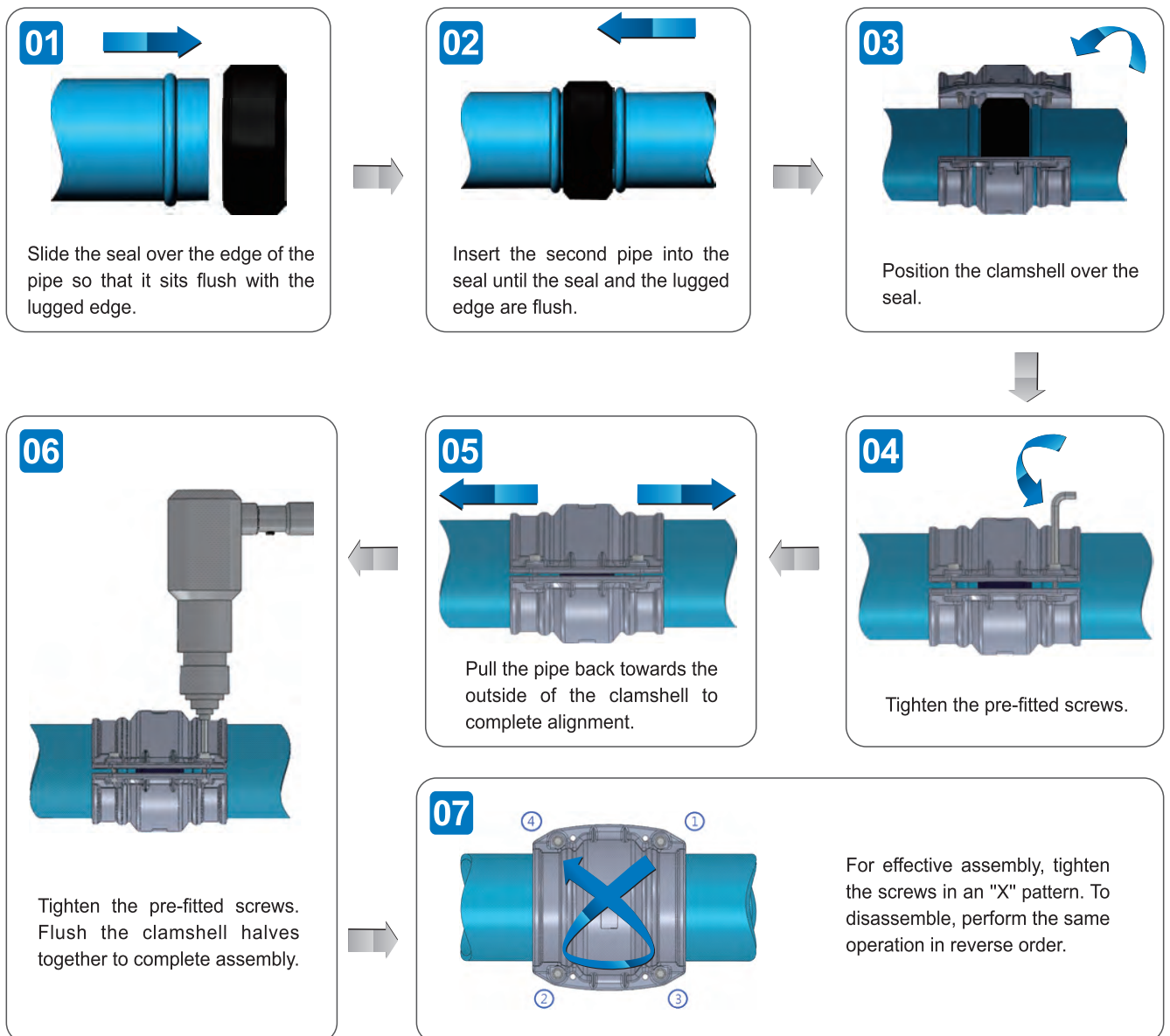

Hand-held hydraulic lugging machine operation requirements



- Manually open the jaws of the clamp and insert the aluminum pipe into the clamp as far as possible.



- Release the jaws. Press the trigger and crimp the pipe until a "snap" sound is heard.

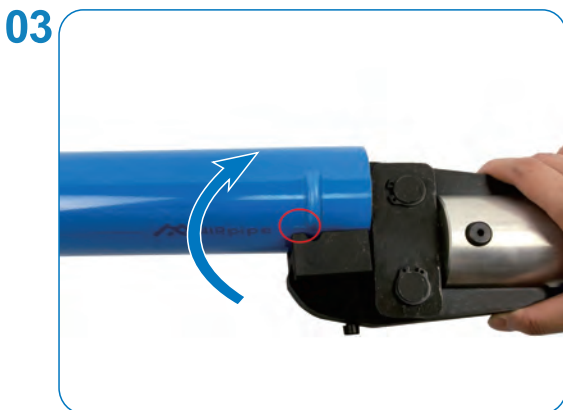

- Re-open the two jaws to remove the pipe and rotate the pipe slightly. Put the jaw side to the mark position.

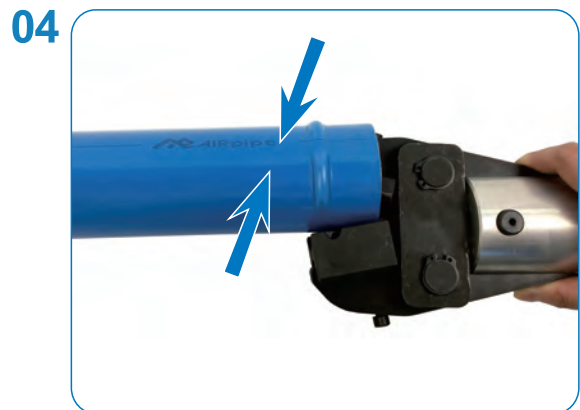

- Renew the operation until the required minimum number of lugs for each diameter is finished.

Hand-held hydraulic lugging machine operation requirements

AIRPIPE	DN63	DN80	DN100	DN150	DN200
Min. number of lugs	5	6	6	9	12

* Note: Do not overlap the lugs!

Pipe Clip

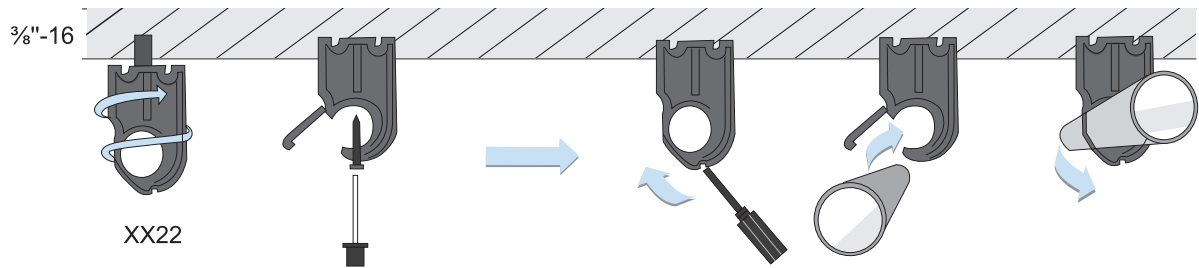

AIRpipe's pipe clips are designed for versatility. They can be secured via all-thread rod through the clips internal $\frac{3}{8}$ "-16 nut, or mounted directly with wall anchors.

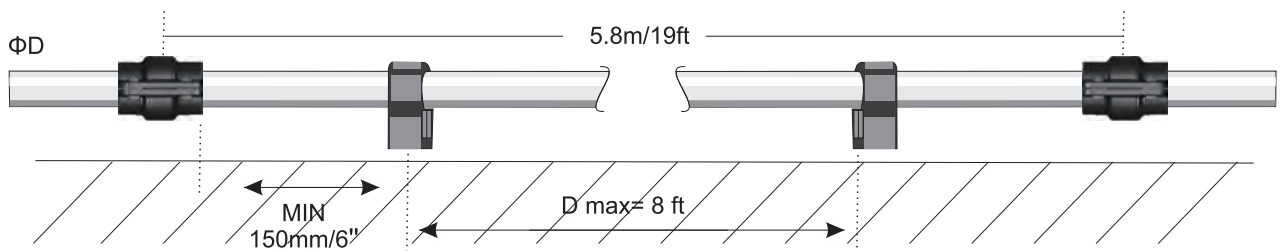

The bolt size $\frac{3}{8}$ "-16 is suitable for all fixing clips.

This clip allows expansion and contraction of the pipe to occur freely. The fixing clip should be fixed at the min. distance of 6 inch (150mm) from the connector in order to allow for the expansion and contraction effect .

Spacers for pipe clips

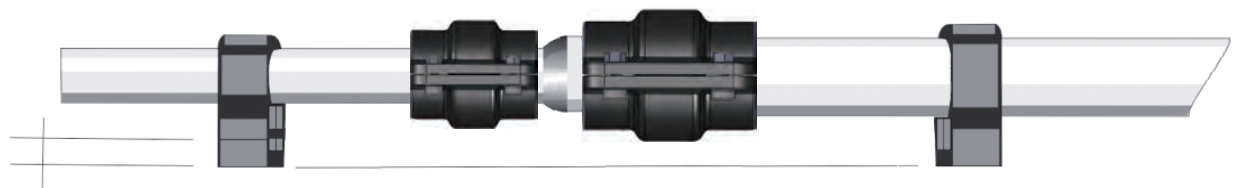

0027
Φ20-25mm/ $\frac{3}{4}$ "- 1"

0127
Φ40-63mm/ 1- $\frac{1}{2}$ "- 2- $\frac{1}{2}$ "

Spacer clip 0027 is used to create a level plane for $\frac{3}{4}$ " or 1" diameters transitioning to 1- $\frac{1}{2}$ ", 2", or 2- $\frac{1}{2}$ ".

Spacer clip 0127 is used to create a level plane for 1- $\frac{1}{2}$ ", 2", or 2- $\frac{1}{2}$ " diameters transitioning to 3" or 4".

Installing Quick Drop Connectors

01



- Mark the pipe where the hole for the quick drop connector will be installed.

02



- Identify the drill arbor & hole saw bit required by locating the quick drop part number on the sizing chart.
Note: the quick drop part number is located on the connector.

03



- With the proper drill arbor & hole saw bit part numbers identified, thread the hole saw bit onto the drill arbor to create a single drill bit.

04

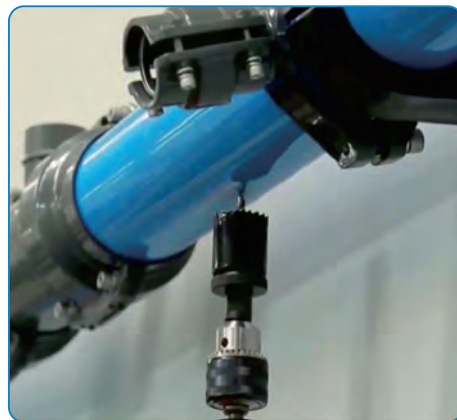

- Hold the drill perpendicular to the pipe with the drill bit in the center of the mark placed on the pipe.

05

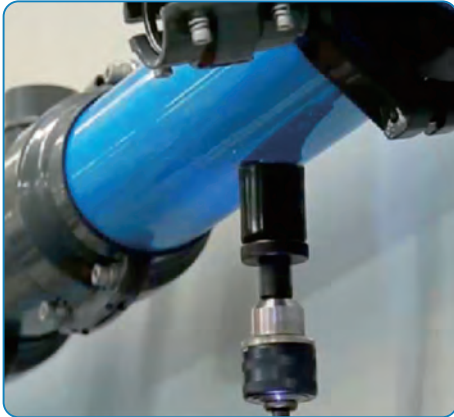

- Apply steady pressure until the hole saw bit has completely entered the pipe.

06

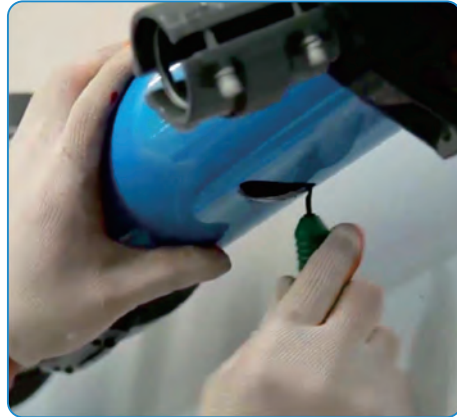

- Remove debris and deburr cut edges.

07



- The quick drop connector easily aligns into the drilled hole.

08

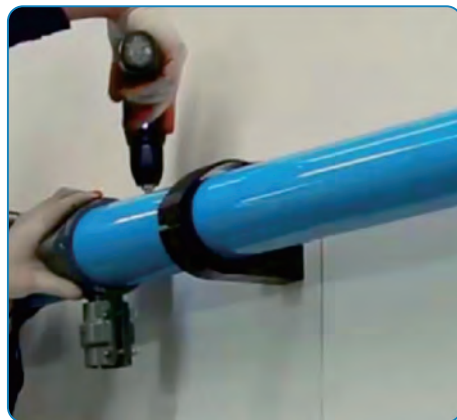

- Tighten the bolt to complete assembly.

Compensating for the effect of expansion and contraction due to temperature variations

Consequences of not properly accounting for thermal variations:

- Leakage and system deformation, that in extreme situations, could result in a connection separation.
- Pipe system movement could create an obstruction.
- Quick drop connections could become compromised.

1. In order to compensate for the effects of expansion and contraction due to temperature variations, system lengths should be appropriately evaluated and expansion joints installed where needed.
 - a. Anytime there is a change in temperature between areas.
 - b. For significant lengths of piping.
2. Recommended locations of flexible hoses or expansion loops include but are not limited to.
 - a. The discharge of the compressor.
 - b. The middle of a long run of pipe.
 - c. Corners of a piping network.
 - d. In a multiple loop at the beginning of a parallel line internal to the pipeline loop.
3. Best practices include but are not limited to:
 - a. All aluminum piping to be installed in strict accordance with AIRpipe installation instructions and specifications .
 - b. Allowing the corners to expand and contract by placing pipe clips an appropriate distance from each corner. Avoid placing a pipe clip directly in the corner.
 - c. Install piping indicated to be exposed and piping in equipment rooms and service areas at right angles or parallel to building walls.
 - d. Install piping adjacent to equipment and machines to allow service and maintenance.
 - e. Install air and drain piping with 1 percent slope downward in direction of flow.
 - f. Install nipples, flanges, unions, transition, and special fittings, and valves with pressure ratings same as or higher than system pressure rating, unless otherwise indicated.
 - g. Install branch connections to compressed-air mains from top of main. Provide drain leg and drain trap at end of each main and branch and at low points.
 - h. Install piping to permit valve servicing.
 - i. Install piping free of sags and bends.
 - j. Install sleeves and escutcheons for piping penetrations of walls, ceilings, and floors as necessary.
 - k. The fixing clips shall allow axial movement of the pipe to compensate for system expansion and contraction.
 - l. Horizontal and vertical AIRpipe piping shall be supported by AIRpipe pipe clips.
Hangers to be spaced at intervals as described herein, as required to avoid sag, prevent vibration, and allow accurate leveling or grading.

Number	ΔT (°C)	Reference table: Allowable max. installation distance L (meters)								
		DN20	DN25	DN40	DN50	DN63	DN80	DN100	DN150	DN200
1	20°C	The pipe can prolong itself	The pipe can prolong itself	120	120	110	105	95	80	75
2	25°C			115	115	105	100	90	75	70
3	30°C			110	110	100	95	85	70	65
4	35°C			100	100	90	90	80	65	60
5	40°C			90	90	85	75	70	60	55

• ΔT = System Temperature - Room Temperature

A1) Single loop pipeline for DN40-DN100

* Use 30° flexible hose in the middle of pipeline

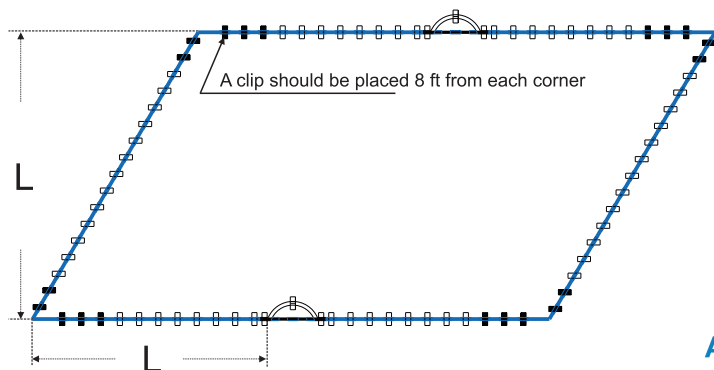

A2) Multiloop pipeline for DN40-DN100

* Use 30° flexible hose in the middle of pipeline

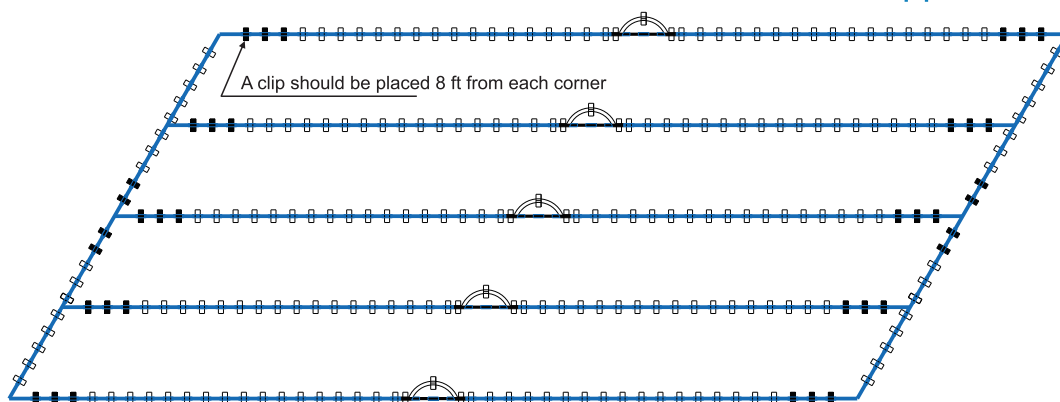

B1) Single loop pipeline for DN150-DN200

* Use two metal hoses in the middle of pipeline

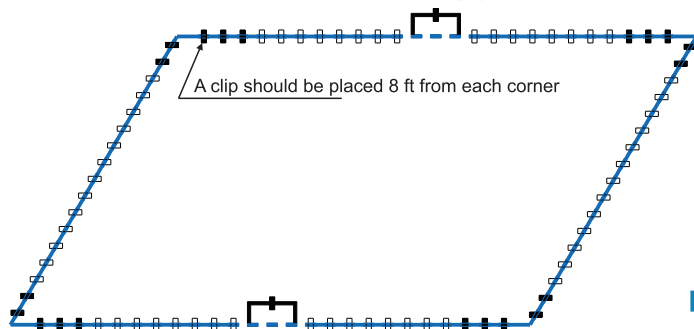

B2) Multiloop pipeline for DN150-DN200

* Use two metal hoses in the middle of pipeline

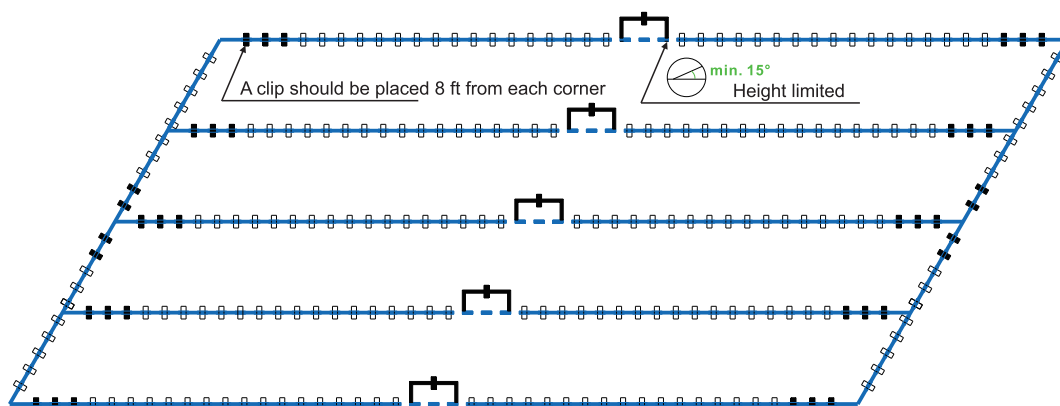

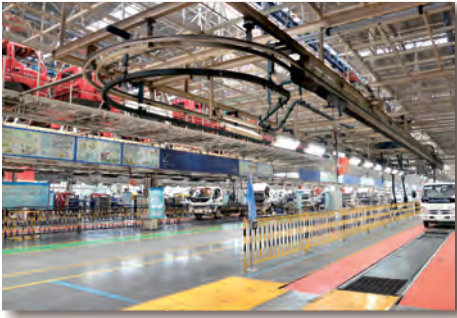

We provide superior performing compressed air & gas systems with engineered longevity to reduce operating costs and improve productivity.



**U.S. Headquarters -
AIRpipe USA**

Tel: 602.362.PIPE (7473)
6855 S. Kyrene Rd, Suite #101, Tempe, AZ 85283
Email: customerservice@airpipeusa.com
Web: www.airpipeusa.com

