



ADAPTER AND FITTING PRODUCT GUIDE

Corporate Sales

3000 Avenue F
Arlington, TX 76011
800-348-8467
fax (817) 860-8517

7177 Railspur Street
Houston, Texas 77078
800-633-5340
fax (713) 672-8101

3450 Blackmore Rd.
Perry, OH 44081
800-348-8467
fax (817) 860-8517

1507 Gladiola Street
Salt Lake City, UT 84104
800-348-8467
fax (817) 860-8517

CFA Industries - FUI
40 Engelhard Drive, Unit 6
Aurora, Ontario L4G 6X6
877-644-4403
fax (905) 713-3927

FIS, Inc. - FUI
5110 - F Fulton Industrial Blvd.
Atlanta, GA 30336
800-348-8467
fax (817) 860-8517

INDEX







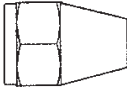

| | |
|---|--------------------|
| Import Steel Adapters | 1 |
| Import Flareless Steel | 7 |
| Import O-Ring Face Seal. | 9 |
| Import Flange Adapters | 11 |
| Import Stainless Steel Adapters | 13 |
| Brass Fittings and Accessories | 16 |
| International and Conversion Adapters | 31 |

***“It is the policy of Fittings Unlimited, Inc.
to maintain and improve our customer satisfaction by
providing hydraulic and pneumatic fittings and
accessories that consistently meet our customer’s
specified product and delivery requirements.”***

Import Steel Adapters

TUBE FITTINGS, J.I.C. - S.A.E.

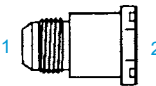
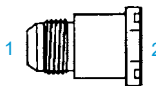
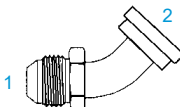
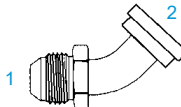
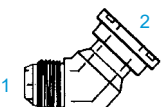
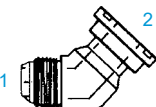
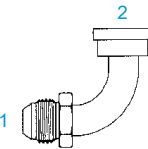
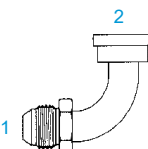
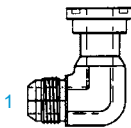
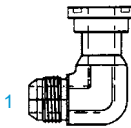
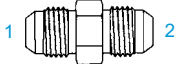
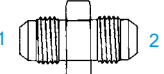
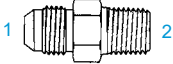
| Dash Number | 2 | 3 | 4 | 5 | 6 | 8 | 10 | 12 | 14 | 16 | 20 | 24 | 32 |
|------------------|---------|--------|--------|--------|--------|--------|--------|-----------|-----------|-----------|--------------|--------------|----------|
| Tube O.D. | 1/8 | 3/16 | 1/4 | 5/16 | 3/8 | 1/2 | 5/8 | 3/4 | 7/8 | 1 | 1-1/4 | 1-1/2 | 2 |
| Straight Thread | 3/16-24 | 3/8-24 | 1/2-20 | 1/2-20 | 3/8-18 | 3/4-16 | 1/2-14 | 1 1/16-12 | 1 3/16-12 | 1 5/16-12 | 1 5/8-12 | 1 7/8-12 | 2 1/2-12 |
| Pipe Thread Std. | 1/8-27 | 1/8-27 | 1/8-27 | 1/8-27 | 1/4-18 | 3/8-18 | 1/2-14 | 3/4-14 | 3/4-14 | 1-11 1/2 | 1 1/4-11 1/2 | 1 1/2-11 1/2 | 2-11 1/2 |

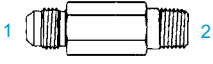
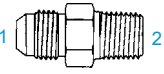
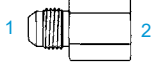
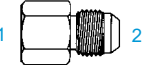
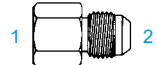
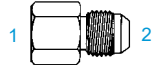
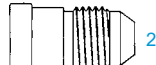
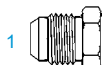
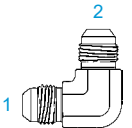
| | | | | | |
|---|---|--|---|---|---|
|  Y-0302 Short Nut |  Y-0304 Standard Nut | 070112  Y-0304-C 37° Cap Nut | 070118  Y-0306 Bulkhead Lock Nut |  Y-0306-N Adjustable Lock Nut | 070110  Y-0318 37° Nut |
| 070115  Y-0319 37° Sleeve |  Y-1700-61 - Str. (1) Male 37° (2) O-Ring Flange Code 61 |  Y-1700-62 - Str. (1) Male 37° (2) O-Ring Flange Code 62 |  Y-1703-61 - 45° (1) Male 37° (2) O-Ring Flange Code 61 |  Y-1703-62 - 45° (1) Male 37° (2) O-Ring Flange Code 62 |  Y-1703-F-61 - 45° (1) Male 37° (2) O-Ring Flange Code 61 |
|  Y-1703-F-62 - 45° (1) Male 37° (2) O-Ring Flange Code 62 |  Y-1704-61 - 90° (1) Male 37° (2) O-Ring Flange Code 61 |  Y-1704-62 - 90° (1) Male 37° (2) O-Ring Flange Code 62 |  Y-1704-F-61 - 90° (1) Male 37° (2) O-Ring Flange Code 61 |  Y-1704-F-62 - 90° (1) Male 37° (2) O-Ring Flange Code 62 | 070101  Y-2403 - Str. (1)(2) Male 37° Union |
| 070119  Y-2403-LH - Str. (1)(2) Male 37° Union Large Hex | 070102  Y-2404 - Str. (1) Male 37° (2) Male Pipe | 070102L  Y-2404-L - Str. (1) Male 37° (2) Male Pipe-Long |  Y-2404-LL - Str. (1) Male 37° (2) Male Pipe-Ex. Long | 070102  RESTRICTOR Y-2404-R - Str. (1) Male 37° (2) Male Pipe | 070103  Y-2405 - Str. (1) Male 37° (2) Fem. Pipe |
| 070123  Y-2406 - Str. Reducer & Expander (1) 37° Fem. (2) Male 37° |  BLANK Y-2406-BLK - Str. Reducer and Expander (1) 37° Fem. (2) Male 37° |  RESTRICTOR Y-2406-R - Str. Reducer and Expander (1) 37° Fem. (2) Male 37° |  Y-2407 - Str. Reducer (1) 37° Fem. (2) Male 37° | 070109  Y-2408 (1) Male 37° Plug | 070201  Y-2500-F - 90° (1)(2) Male 37° |



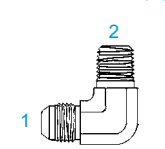
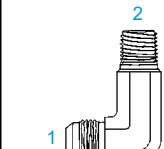
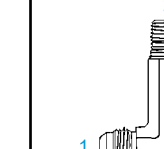
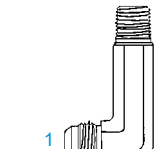
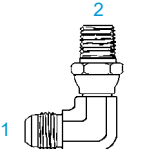
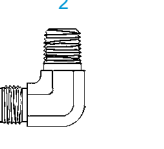
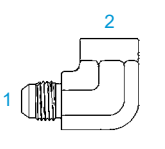
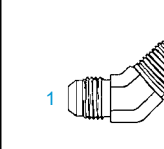
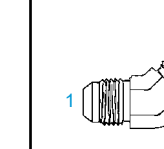
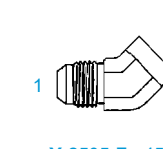
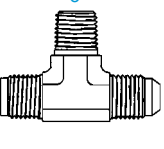
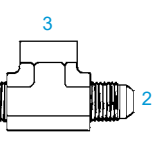
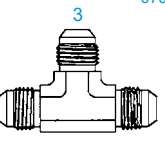
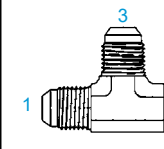
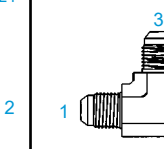
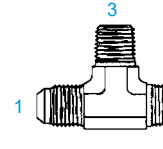
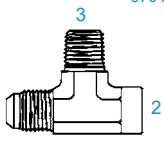
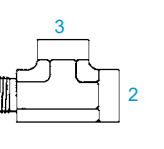
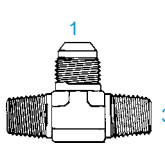
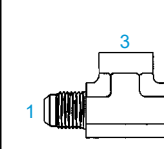
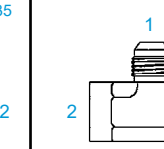
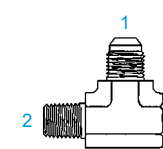
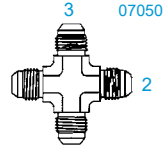
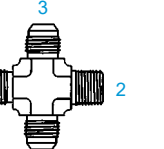
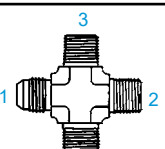
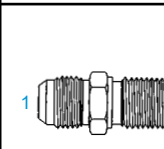
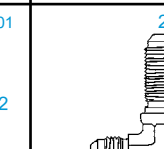
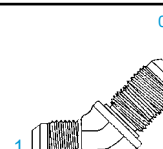
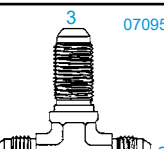
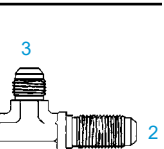
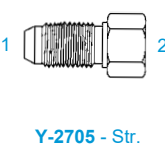
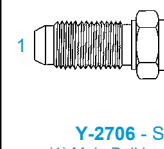
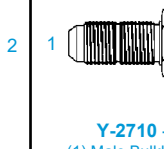
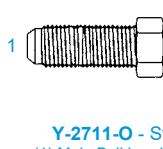

TUBE FITTINGS, J.I.C.- S.A.E., Continued

STEEL FITTINGS

| | | | | | |
|--|--|---|---|---|--|
| <p>070202</p>  <p>Y-2501-F - 90° (1) Male 37° (2) Male Pipe</p> | <p>071502</p>  <p>Y-2501-F-L - 90° (1) Male 37° (2) Male Pipe-Long</p> | <p>071602</p>  <p>Y-2501-F-LL - 90° (1) Male 37° (2) Male Pipe-Ex. Long</p> | <p>2</p>  <p>Y-2501-F-LLL - 90° (1) Male 37° (2) Male Pipe-Ex. Ex. Long</p> | <p>2</p>  <p>Y-2501-F-S - 90° (1) Male 37° (2) Male Pipe Swivel</p> | <p>2</p>  <p>RESTRICTOR Y-2501-F-R - 90° (1) Male 37° (2) Male Pipe</p> |
| <p>070203</p>  <p>Y-2502-F - 90° (1) Male 37° (2) Fem. Pipe</p> | <p>070302</p>  <p>Y-2503-F - 45° (1) Male 37° (2) Male Pipe</p> | <p>070301</p>  <p>Y-2504-F - 45° (1)(2) Male 37°</p> | <p>2</p>  <p>Y-2505-F - 45° (1) Male 37° (2) Fem. Pipe</p> | <p>070425</p>  <p>Y-2601-F - Tee (1)(2) Male 37° (3) Male Pipe</p> | <p>070427</p>  <p>Y-2602-F - Tee (1)(2) Male 37° (3) Fem. Pipe</p> |
| <p>070401</p>  <p>Y-2603-F - Tee (1)(2)(3) Male 37°</p> | <p>070424</p>  <p>Y-2605-F - Tee (1)(3) Male 37° (2) Male Pipe</p> | <p>070426</p>  <p>Y-2606-F - Tee (1)(3) Male 37° (2) Fem. Pipe</p> | <p>3</p>  <p>Y-2607-F - Tee (1) Male 37° (2)(3) Male Pipe</p> | <p>070434</p>  <p>Y-2608-F - Tee (1) Male 37° (2) Fem. Pipe (3) Male Pipe</p> | <p>3</p>  <p>Y-2609-F - Tee (1) Male 37° (2)(3) Fem. Pipe</p> |
| <p>1</p>  <p>Y-2610-F - Tee (1) Male 37° (2)(3) Male Pipe</p> | <p>070435</p>  <p>Y-2611-F - Tee (1) Male 37° (2) Male Pipe (3) Fem. Pipe</p> | <p>1</p>  <p>Y-2612-F - Tee (1) Male 37° (2)(3) Fem. Pipe</p> | <p>1</p>  <p>Y-2613-F - Tee (1) Male 37° (2) Male Pipe (3) Fem. Pipe</p> | <p>3</p>  <p>Y-2650-F - Cross (1)(2)(3)(4) Male 37°</p> | <p>3</p>  <p>Y-2651-F - Cross (1)(3)(4) Male 37° (2) Male Pipe</p> |
| <p>3</p>  <p>Y-2655-F - Cross (1) Male 37° (2)(3)(4) Male Pipe</p> | <p>070601</p>  <p>Y-2700 - Str. (1) Male 37° (2) Male Bulkhead 37°</p> | <p>2</p>  <p>Y-2701-F - 90° (1) Male 37° (2) Male Bulkhead 37°</p> | <p>070801</p>  <p>Y-2702-F - 45° (1) Male 37° (2) Male Bulkhead 37°</p> | <p>070959</p>  <p>Y-2703-F - Tee (1)(2) Male 37° (2) Male Bulkhead 37°</p> | <p>3</p>  <p>Y-2704-F - Tee (1)(3) Male 37° (2) Male Bulkhead 37°</p> |
| <p>1</p>  <p>Y-2705 - Str. (1) Male Bulkhead 37° (2) Fem. Pipe</p> | <p>1</p>  <p>Y-2706 - Str. (1) Male Bulkhead 37° (2) Male Pipe</p> | <p>1</p>  <p>Y-2710 - Str. (1) Male Bulkhead 37° (2) Fem. O-Ring</p> | <p>1</p>  <p>Y-2711-O - Str. (1) Male Bulkhead 37° (2) Male O-Ring</p> | <p>Bulkheads also available with locknut. Add LN to base number "Y-2700-LN"</p> | |

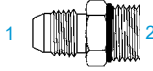
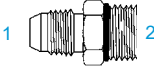
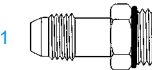
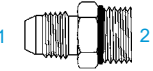
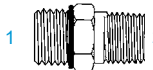
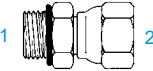
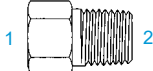
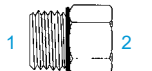
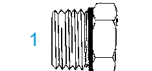

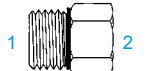
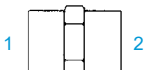
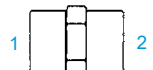
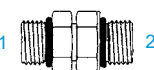
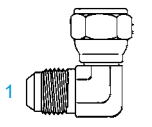
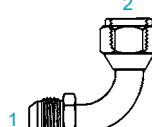
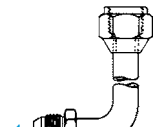
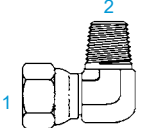
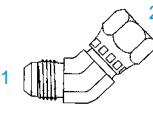
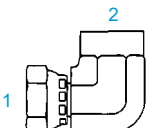
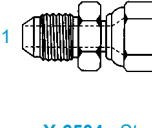
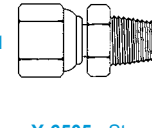
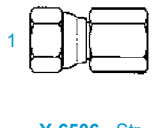
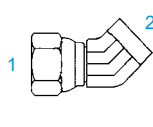
ADJUSTABLE & O-RING FITTINGS

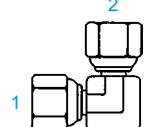
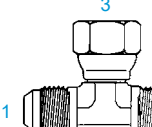
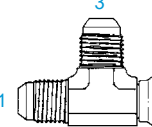
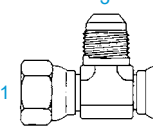
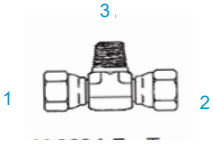
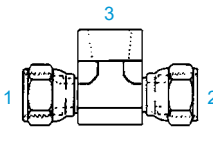
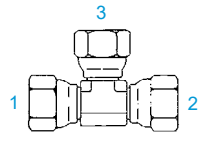
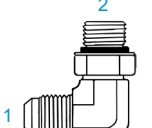
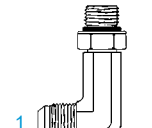
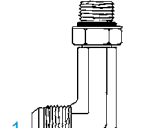
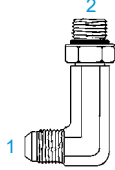
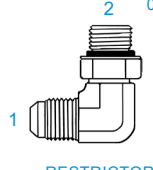
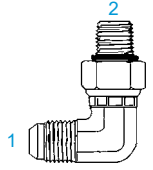
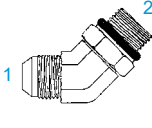
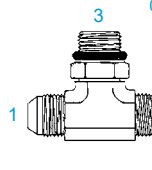
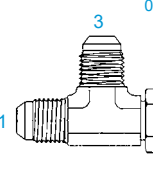
(Refer to Tube Fittings, "JIC-SAE" Chart for sizes)

| | | | | | |
|--|---|--|--|---|--|
|  <p>4000 - O-Ring Buna-N 90 Duro</p> | <p>070122</p>  <p>BLANK Y-6400-BLK-O (1) Male 37° (2) Male O-Ring</p> | <p>070122</p>  <p>Y-6400-O - Str. (1) Male 37° (2) Male O-Ring</p> | <p>070120</p>  <p>Y-6400-L-O - Str. (1) Male 37° (2) Male O-Ring - Long</p> | <p>070122</p>  <p>RESTRICTOR Y-6400-R-O (1) Male 37° (2) Male O-Ring</p> |  <p>Y-6401-O - Str. (1) Male O-Ring (2) Male Pipe</p> |
|  <p>Y-6402-O - Str. (1) Male O-Ring (2) 37° Fem. Swivel</p> |  <p>Y-6404 - Str. (1) Fem. O-Ring (2) Male Pipe</p> |  <p>Y-6405-O - Str. (1) Male O-Ring (2) Fem. Pipe</p> |  <p>Y-6408-O - Str. (1) Male O-Ring Plug</p> |  <p>Y-6408-HHP-O (1) Hollow Hex Male O-Ring Plug</p> |  <p>Y-6410-O - Str. (1) Male O-Ring (2) Fem. O-Ring</p> |
|  <p>Y-6412 - Str. (1) Fem. O-Ring (2) Fem. Pipe</p> |  <p>Y-6413 - Str. (1)(2) Fem. O-Ring</p> |  <p>Y-6464-NWO - Str. (1) Male O-Ring (2) Adj. O-Ring</p> | <p>070221</p>  <p>Y-6500-F - 90° (1) Male 37° (2) 37° Fem. Swivel</p> |  <p>Y-6500-L - 90° (1) Male 37° (2) 37° Fem. Swivel-Long</p> |  <p>Y-6500-LL - 90° (1) Male 37° (2) 37° Fem. Swivel -Ex. Long</p> |
|  <p>Y-6501-F - 90° (1) 37° Fem. Swivel (2) Male Pipe</p> |  <p>Y-6502-F - 45° (1) Male 37° (2) 37° Fem. Swivel</p> |  <p>Y-6503-F - 90° (1) 37° Fem. Swivel (2) Fem. Pipe</p> |  <p>Y-6504 - Str. (1) Male 37° (2) 37° Fem. Swivel</p> |  <p>Y-6505 - Str. (1) 37° Fem. Swivel (2) Male Pipe</p> |  <p>Y-6506 - Str. (1) 37° Fem. Swivel (2) Fem. Pipe</p> |
|  <p>Y-6507-F - 45° (1) 37° Fem. Swivel (2) Fem. Pipe</p> |  <p>Y-6565 - Str. (1)(2) 37° Fem. Swivel</p> |  <p>Y-6566-F - 90° (1)(2) 37° Fem. Swivel</p> |  <p>Y-6600-F - Tee (1)(2) Male 37° (3) 37° Fem. Swivel</p> | <p>070433</p>  <p>Y-6602-F - Tee (1)(3) Male 37° (2) 37° Fem. Swivel</p> |  <p>Y-6603-F - Tee (1)(2) 37° Fem. Swivel (3) Male 37°</p> |
|  <p>Y-6604-F - Tee (1)(2) 37° Fem. Swivel (3) Male Pipe</p> |  <p>Y-6605-F - Tee (1)(2) 37° Fem. Swivel (3) Fem. Pipe</p> |  <p>Y-6606-F - Tee (1)(2)(3) 37° Fem. Swivel</p> | <p>070220</p>  <p>Y-6801-F-NWO - 90° (1) Male 37° (2) Adj. O-Ring</p> |  <p>Y-6801-F-L-NWO - 90° (1) Male 37° (2) Adj. O-Ring-Long</p> |  <p>Y-6801-F-LL-NWO - 90° (1) Male 37° (2) Adj. O-Ring-Ex. Long</p> |
|  <p>Y-6801-F-LLL-NWO - 90° (1) Male 37° (2) Adj. O-Ring-Ex. Ex. Long</p> | <p>070220</p>  <p>RESTRICTOR Y-6801-F-R-NWO - 90° (1) Male 37° (2) Adj. O-Ring</p> |  <p>Y-6801-F-S-O - 90° (1) Male 37° (2) Male O-Ring Swivel</p> | <p>070320</p>  <p>Y-6802-F-NWO - 45° (1) Male 37° (2) Adj. O-Ring</p> | <p>070429</p>  <p>Y-6803-F-NWO - Tee (1)(2) Male 37° (3) Adj. O-Ring</p> | <p>070428</p>  <p>Y-6804-F-NWO - Tee (1)(3) Male 37° (2) Adj. O-Ring</p> |

ADJUSTABLE & O-RING FITTINGS

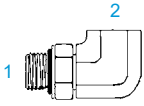
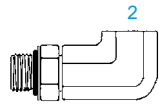
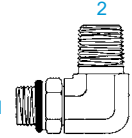
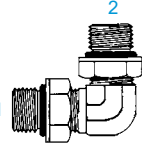
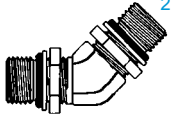
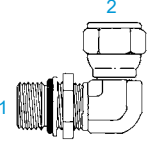
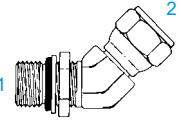
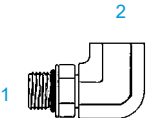
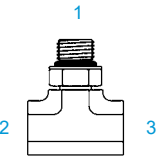
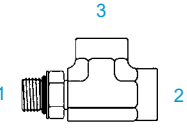
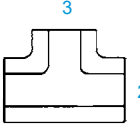
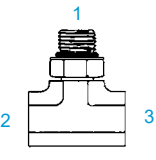
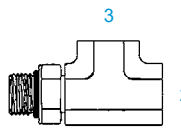
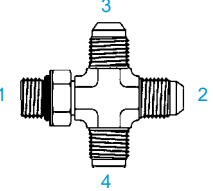
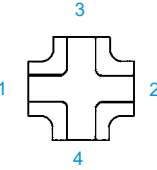
(Refer to Tube Fittings, "JIC-SAE" Chart for sizes)

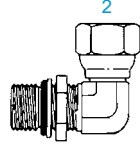
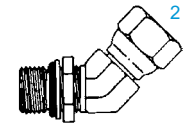
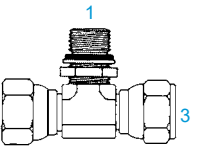
| | | | | | |
|--|--|---|---|---|---|
|  <p>Y-6805-F-NWO - 90° (1) Adj. O-Ring (2) Fem. Pipe</p> |  <p>Y-6805-F-LL-NWO - 90° (1) Adj. O-Ring (2) Fem. Pipe-Ex. Long</p> |  <p>Y-6806-F-NWO - 90° (1) Adj. O-Ring (2) Male Pipe</p> |  <p>Y-6807-F-NWO - 90° (1)(2) Adj. O-Ring</p> |  <p>Y-6808-F-NWO - 45° (1)(2) Adj. O-Ring</p> |  <p>Y-6809-F-NWO - 90° (1) Adj. O-Ring (2) 37° Fem. Swivel</p> |
|  <p>Y-6810-F-NWO - 45° (1) Adj. O-Ring (2) 37° Fem. Swivel</p> |  <p>Y-6815-F-NWO - 90° (1) Adj. O-Ring (2) Fem. O-Ring</p> |  <p>Y-6863-F-NWO - Tee (1) Adj. O-Ring (2)(3) Fem. Pipe</p> |  <p>Y-6864-F-NWO - Tee (1) Adj. O-Ring (2)(3) Fem. Pipe</p> |  <p>Y-6868-F - Tee (1)(2)(3) Fem. O-Ring</p> |  <p>Y-6870-F-NWO - Tee (1) Adj. O-Ring (2)(3) Fem. O-Ring</p> |
|  <p>Y-6871-F-NWO - Tee (1) Adj. O-Ring (2)(3) Fem. O-Ring</p> |  <p>Y-6889-F-NWO - Cross (1) Adj. O-Ring (2)(3)(4) Male 37°</p> |  <p>Y-6892-F - Cross (1)(2)(3)(4) Fem. O-Ring</p> |  <p>Y-6900-O - Str. (1) Adj. O-Ring (2) Fem. Pipe Swivel</p> |  <p>Y-6901-F-NWO - 90° (1) Adj. O-Ring (2) Fem. Pipe Swivel</p> |  <p>Y-6902-F-NWO - 45° (1) Adj. O-Ring (2) Fem. Pipe Swivel</p> |
|  <p>Y-6911-F-NWO - Tee (1) Adj. O-Ring (2)(3) Fem. Pipe Swivel</p> | | | | | |

BEADED HOSE ADAPTERS

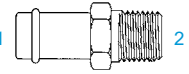
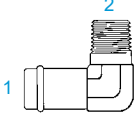
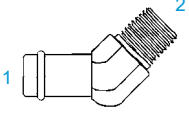
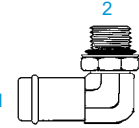
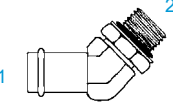
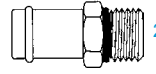
| | | | | | |
|--|---|---|---|---|--|
| <p>430160</p>  <p>Y-4404 - Str. (1) Beaded (2) Male Pipe</p> | <p>430260</p>  <p>Y-4501-F - 90° (1) Beaded (2) Male Pipe</p> | <p>430360</p>  <p>Y-4503-F - 45° (1) Beaded (2) Male Pipe</p> |  <p>Y-4601-F-NWO - 90° (1) Beaded (2) Adj. O-Ring</p> |  <p>Y-4603-F-NWO - 45° (1) Beaded (2) Adj. O-Ring</p> |  <p>Y-4604-O - Str. (1) Beaded (2) Male O-Ring</p> |
|--|---|---|---|---|--|

BRAZE FITTINGS FOR TUBING

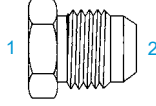
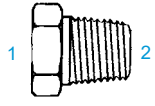

(Refer to "Tube Fittings, JIC-SAE" Chart for sizes)

| | | | | |
|--|---|--|--|--|
|  <p>Y-0403 (1) Bore (2) Male 37°</p> |  <p>Y-0404 (1) Bore (2) Male Pipe</p> | | | |
|--|---|--|--|--|

PIPE ADAPTER UNIONS

Refer to Chart below for Sizes

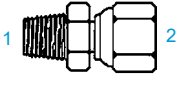

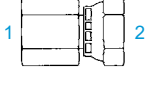
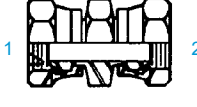
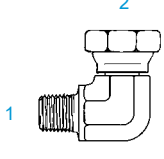
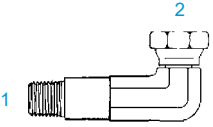
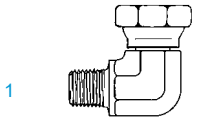
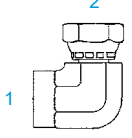
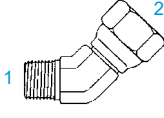
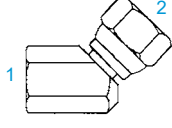
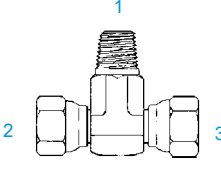
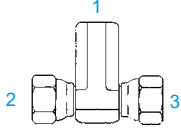
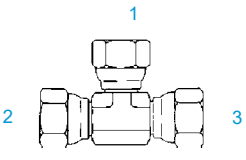
| Dash Number | 2 | 4 | 6 | 8 | 12 | 16 | 20 | 24 | 32 |
|---------------------------------|--------|--------|--------|--------|--------|----------|--------------|--------------|----------|
| Pipe Thread Std. NPSM - NPTF | 1/8-27 | 1/4-18 | 3/8-18 | 1/2-14 | 3/4-14 | 1-11 1/2 | 1 1/4-11 1/2 | 1 1/2-11 1/2 | 2-11 1/2 |

| | | | | |
|--|--|---|--|---|
| <p>140130</p>  <p>Y-1404 - Str. (1) Male Pipe (2) Fem. Pipe Swivel</p> | <p>140131</p>  <p>RESTRICTOR Y-1404-R - Str. (1) Male Pipe (2) Fem. Pipe Swivel</p> |  <p>Y-1405 - Str. (1) Fem. Pipe (2) Fem. Pipe Swivel</p> |  <p>Y-1406 - Str. (1) Fem. Pipe (2) Fem. Pipe Swivel</p> | <p>140230</p>  <p>Y-1501-F - 90° (1) Male Pipe (2) Fem. Pipe Swivel</p> |
|  <p>Y-1501-F-LL - 90° (1) Male Pipe (2) Fem. Pipe Swivel</p> | <p>140330</p>  <p>RESTRICTOR Y-1501-F-R - 90° (1) Male Pipe (2) Fem. Pipe Swivel</p> |  <p>Y-1502-F - 90° (1) Fem. Pipe (2) Fem. Pipe Swivel</p> |  <p>Y-1503-F - 45° (1) Male Pipe (2) Fem. Pipe Swivel</p> |  <p>Y-1504-F - 45° (1) Fem. Pipe (2) Fem. Pipe Swivel</p> |
|  <p>Y-1601-F - Tee (1) Male Pipe (2)(3) Fem. Pipe Swivel</p> |  <p>Y-1602-F - Tee (1) Fem. Pipe (2)(3) Fem. Pipe Swivel</p> |  <p>Y-1603-F - Tee (1)(2)(3) Fem. Pipe Swivel</p> | | |

PIPE FITTINGS



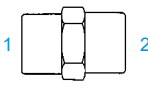
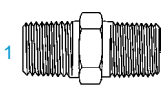
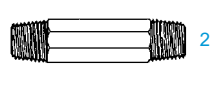
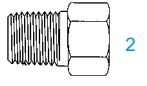
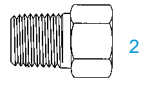
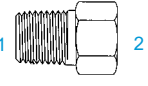
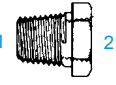

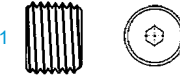
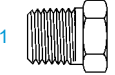
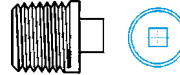
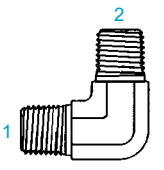
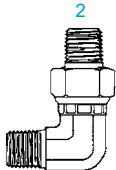
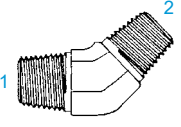
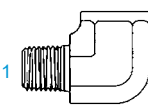
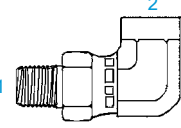
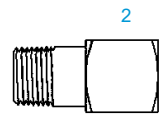
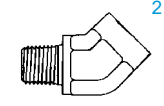
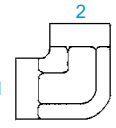
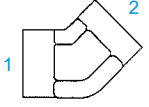
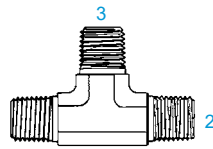
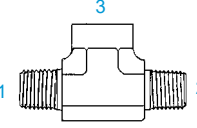
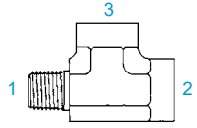
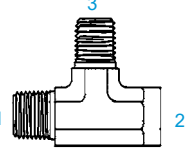
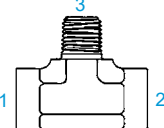
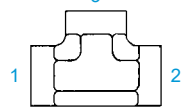
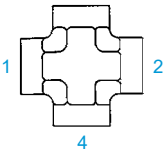
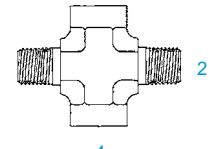
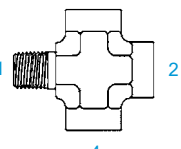

Refer to Chart below for Sizes

| Dash Number | 2 | 4 | 6 | 8 | 12 | 16 | 20 | 24 | 32 |
|---------------------------------|--------|--------|--------|--------|--------|----------|--------------|--------------|----------|
| Pipe Thread Std. NPSM - NPTF | 1/8-27 | 1/4-18 | 3/8-18 | 1/2-14 | 3/4-14 | 1-11 1/2 | 1 1/4-11 1/2 | 1 1/2-11 1/2 | 2-11 1/2 |

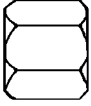
| | | | | | |
|--|--|---|---|---|---|
| <p>140138</p>  <p>Y-5000 - Str. (1)(2) Fem. Pipe</p> | <p>140137</p>  <p>Y-5404 - Str. (1)(2) Male Pipe</p> | <p>140139</p>  <p>Y-5404-N - Str. Nipple (1)(2) Male Pipe</p> | <p>140139</p>  <p>Y-5405 - Str. (1) Male Pipe (2) Fem. Pipe</p> | <p>140139</p>  <p>BLANK Y-5405-BLK - Str. (1) Male Pipe (2) Fem. Pipe</p> | <p>140139</p>  <p>RESTRICTORS Y-5405-R - Str. (1) Male Pipe (2) Fem. Pipe</p> |
| <p>140140</p>  <p>Y-5406 - Str. Bushing (1) Male Pipe (2) Fem. Pipe</p> | <p>140140</p>  <p>Y-5406-C Pipe Cap</p> | <p>140140</p>  <p>Y-5406-HHP (1) Hollow Hex Pipe Plug</p> | <p>130109E</p>  <p>Y-5406-P - Plug (1) Pipe Plug</p> | <p>130109E</p>  <p>Y-5406-SHP (1) Pipe plug Square Head</p> | <p>140140</p>  <p>Y-5500-F - 90° (1)(2) Male Pipe</p> |
| <p>140238</p>  <p>Y-5500-F-S - 90° (1) Male Pipe (2) Male Pipe Swivel</p> | <p>140238</p>  <p>Y-5501-F - 45° (1) (2) Male Pipe</p> | <p>140239</p>  <p>Y-5502-F - 90° (1) Male Pipe (2) Fem. Pipe</p> | <p>140239</p>  <p>Y-5502-F-S - 90° (1) Male Pipe Swivel (2) Fem. Pipe</p> | <p>140239</p>  <p>Y-5502-SB - 90° Short Body (1) Male Pipe (2) Fem. Pipe</p> | <p>140339</p>  <p>Y-5503-F - 45° (1) Male Pipe (2) Fem. Pipe</p> |
| <p>140238</p>  <p>Y-5504-F - 90° (1)(2) Fem. Pipe</p> | <p>140338</p>  <p>Y-5505-F - 45° (1)(2) Fem. Pipe</p> | <p>140238</p>  <p>Y-5600-F - Tee (1)(2)(3) Male Pipe</p> | <p>140238</p>  <p>Y-5601-F - Tee (1)(2) Male Pipe (3) Fem. Pipe</p> | <p>140424</p>  <p>Y-5602-F - Tee (1) Male Pipe (2)(3) Fem. Pipe</p> | <p>140238</p>  <p>Y-5603-F - Tee (1)(3) Male Pipe (2) Fem. Pipe</p> |
| <p>140425</p>  <p>Y-5604-F - Tee (1)(2) Fem. Pipe (3) Male Pipe</p> | <p>140438</p>  <p>Y-5605-F - Tee (1)(2)(3) Fem. Pipe</p> | <p>140425</p>  <p>Y-5652-F - Cross (1)(2)(3)(4) Fem. Pipe</p> | <p>140425</p>  <p>Y-5653-F - Cross (1)(2) Male Pipe (3)(4) Fem. Pipe</p> | <p>140425</p>  <p>Y-5655-F - Cross (1) Male Pipe (2)(3)(4) Fem. Pipe</p> | |

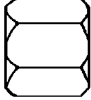
Import Flareless Steel

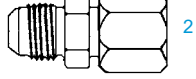
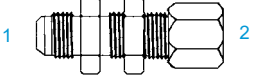
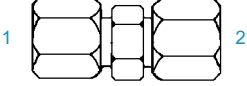
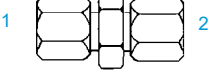
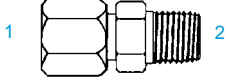
| Dash Number | 2 | 3 | 4 | 5 | 6 | 8 | 10 | 12 | 14 | 16 | 20 | 24 | 32 |
|------------------|---------|--------|---------|--------|---------|--------|--------|-----------|-----------|-----------|--------------|--------------|----------|
| Tube O.D. | 1/8 | 3/16 | 1/4 | 5/16 | 3/8 | 1/2 | 5/8 | 3/4 | 7/8 | 1 | 1-1/4 | 1-1/2 | 2 |
| Straight Thread | 5/16-24 | 3/8-24 | 7/16-20 | 1/2-20 | 9/16-18 | 3/4-16 | 7/8-14 | 1 1/16-12 | 1 3/16-12 | 1 5/16-12 | 1 5/8-12 | 1 7/8-12 | 2 1/2-12 |
| Pipe Thread Std. | 1/8-27 | 1/8-27 | 1/8-27 | 1/8-27 | 1/4-18 | 3/8-18 | 1/2-14 | 3/4-14 | 3/4-14 | 1-11 1/2 | 1 1/4-11 1/2 | 1 1/2-11 1/2 | 2-11 1/2 |

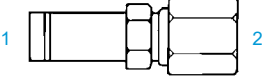
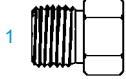
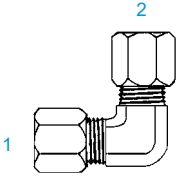
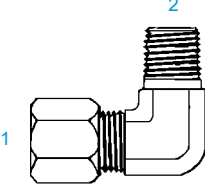
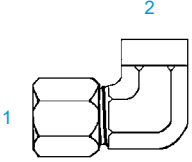
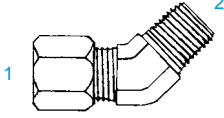
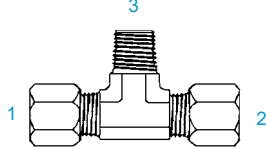
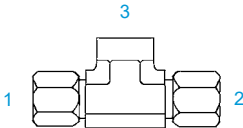
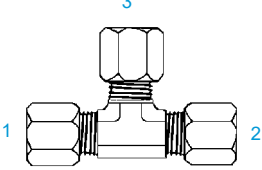
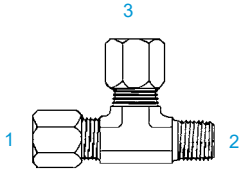
| | | | | |
|---|---|---|---|---|
|  <p>Y-FL-0304-C Cap Nut</p> |  <p>Y-FL-0306 Bulkhead Lock Nut</p> |  <p>Y-FL-0318 Flareless Nut</p> |  <p>Y-FL-0319 Flareless Sleeve</p> |  <p>Y-FL-2000 - Str. (1) Male 37° (2) Male Flareless</p> |
|  <p>Y-FL-2000-BH - Str. (1) Male 37° (2) Bulkhead</p> |  <p>Y-FL-2403 - Str. (1) (2) Male Flareless Union</p> |  <p>Y-FL-2403-LH - Str. (1)(2) Male Flareless Union Large Hex</p> |  <p>Y-FL-2404 - Str. (1) Male Flareless (2) Male Pipe</p> |  <p>Y-FL-2405 - Str. (1) Male Flareless (2) Fem. Pipe</p> |
|  <p>Y-FL-2406 - Str. Reducer (1) Female Flareless (2) Male Flareless</p> |  <p>Y-FL-2408 - Str. (1) Male Flareless Plug</p> |  <p>Y-FL-2500 - 90° (1) (2) Male Flareless</p> |  <p>Y-FL-2501 - 90° (1) Male Flareless (2) Male Pipe</p> |  <p>Y-FL-2502 - 90° (1) Male Flareless (2) Fem. Pipe</p> |
|  <p>Y-FL-2503 - 45° (1) Male Flareless (2) Male Pipe</p> |  <p>Y-FL-2601 - Tee (1)(2) Male Flareless (3) Male Pipe</p> |  <p>Y-FL-2602 - Tee (1)(2) Male Flareless (3) Fem. Pipe</p> |  <p>Y-FL-2603 - Tee (1) (2) (3) Male Flareless</p> |  <p>Y-FL-2605 - Tee (1)(3) Male Flareless (2) Male Pipe</p> |





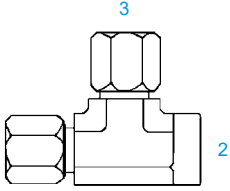
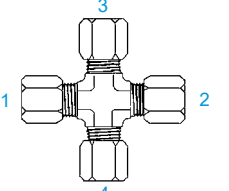
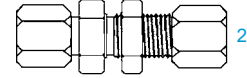
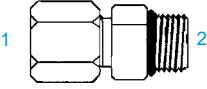
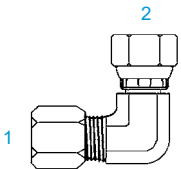
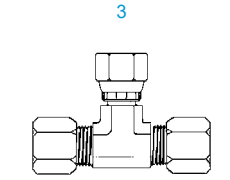
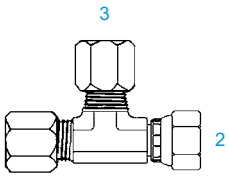
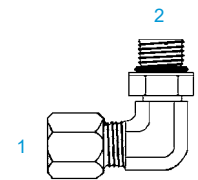
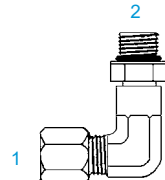
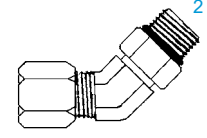
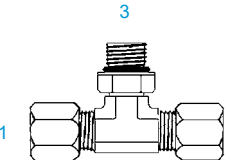
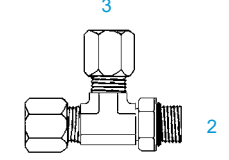

IMPORT FLARELESS STEEL (continued)

FLARELESS STEEL

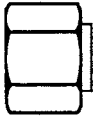
| | | | | |
|---|---|---|---|--|
|  <p>Y-FL-2606 - Tee (1)(3) Male Flareless (2) Fem. Pipe</p> |  <p>Y-FL-2650 - Cross (1)(2)(3)(4) Male Flareless</p> |  <p>Y-FL-2700-LN - Str. (1) Male Flareless (2) Male Flareless Bulkhead with Locknut</p> |  <p>Y-FL-6400-O - Str. (1) Male Flareless (2) Male O-Ring</p> |  <p>Y-FL-6500 - 90° (1) Male Flareless (2) Fem. Flareless Swivel</p> |
|  <p>Y-FL-6600 - Tee (1)(2) Male Flareless (3) Fem. Flareless Swivel</p> |  <p>Y-FL-6602 - Tee (1)(3) Male Flareless (2) Fem. Flareless Swivel</p> |  <p>Y-FL-6801-NWO - 90° (1) Male Flareless (2) Adj. O-Ring</p> |  <p>Y-FL-6801-L-NWO - 90° (1) Male Flareless (2) Adj. O-Ring-Long</p> |  <p>Y-FL-6802-NWO - 45° (1) Male Flareless (2) Adj. O-Ring</p> |
|  <p>Y-FL-6803-NWO - Tee (1)(2) Male Flareless (3) Adj. O-Ring</p> |  <p>Y-FL-6804-NWO - Tee (1)(3) Male Flareless (2) Adj. O-Ring</p> | | | |
| | | | | |
| | | | | |
| | | | | |

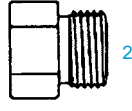
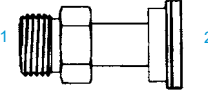
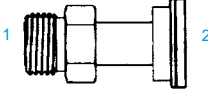
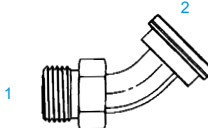
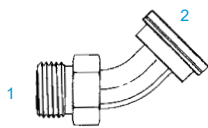
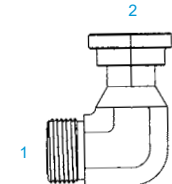
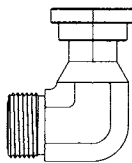
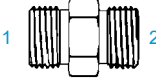
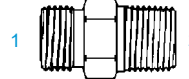
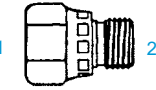
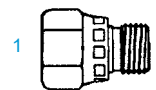
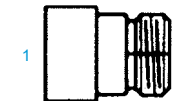

Import O-Ring Face Seal Fittings

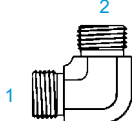
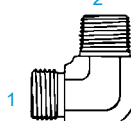
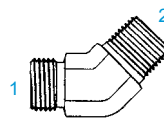
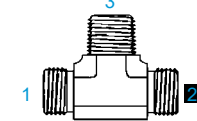
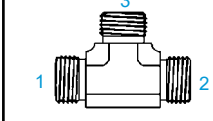
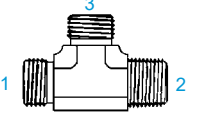
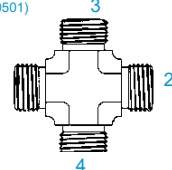
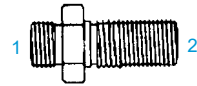
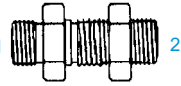
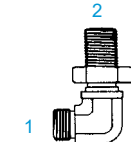
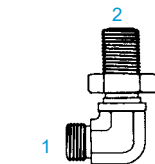
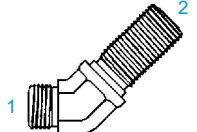
| Dash Number | 4 | 6 | 8 | 10 | 12 | 16 | 20 | 24 |
|--------------------------|------|-------|-------|------|-------|-------|-------|------|
| Tube O.D. | ¼ | ⅜ | ½ | ⅝ | ¾ | 1 | 1-¼ | 1-½ |
| O-Ring Face Seal Thread | ⅞-18 | 1⅛-16 | 1⅜-16 | 1-14 | 1⅜-12 | 1⅞-12 | 1⅛-12 | 2-12 |
| O-Ring Face Seal PSI 4:1 | 6000 | 6000 | 6000 | 6000 | 6000 | 5500 | 4000 | 4000 |
| Adjustable Fittings PSI | 5000 | 5000 | 5000 | 4500 | 4000 | 3000 | 2500 | 2000 |
| Pipe Thread STD 4:1 | 5000 | 4500 | 3000 | | 3000 | 1750 | 1500 | 1500 |

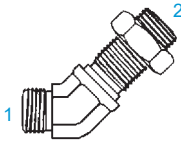
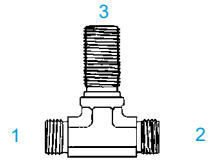
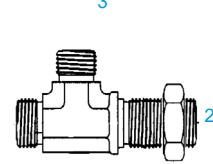
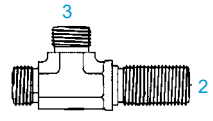
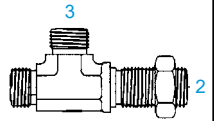
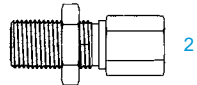
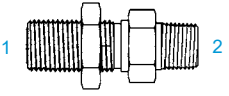
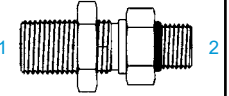

| | | | | | |
|---|--|---|--|--|--|
|  Y-OFS-0304-C Cap Nut | (520118)  Y-OFS-0306 Bulkhead Lock Nut | (520118)  Y-OFS-0318 OFS Nut | (520115)  Y-OFS-0319 OFS Braze Shoulder |  Y-OFS-0333 OFS Sleeve | (520104)  Y-OFS-0403 (1) Bore for Brazing (2) Male OFS |
|  Y-OFS-1700-61 - Str. (1) Male OFS (2) O-Ring Flange Code 61 |  Y-OFS-1700-62 - Str. (1) Male OFS (2) O-Ring Flange Code 62 |  Y-OFS-1703-F-61 - 45° (1) Male OFS (2) O-Ring Flange Code 61 |  Y-OFS-1703-F-62 - 45° (1) Male OFS (2) O-Ring Flange Code 62 |  Y-OFS-1704-F-61 - 90° (1) Male OFS (2) O-Ring Flange Code 61 |  Y-OFS-1704-F-62 - 90° (1) Male OFS (2) O-Ring Flange Code 62 |
| (520101)  Y-OFS-2403 - Str. (1)(2) Male OFS Union |  Y-OFS-2404 - Str. (1) Male OFS (2) Male Pipe |  Y-OFS-2406 - Str. Reducer (1) Fem. OFS (2) Male OFS |  Y-OFS-2406-BLK - Str. BLANK (1) Fem. OFS (2) Male OFS |  Y-OFS-2407 - Str. Reducer Less Nut (1) Fem. OFS (2) Male OFS | (520109)  Y-OFS-2408 (1) Male OFS Plug |
| (520201)  Y-OFS-2500-F - 90° (1)(2) Male OFS Union |  Y-OFS-2501-F - 90° (1) Male OFS (2) Male Pipe |  Y-OFS-2503-F - 45° (1) Male OFS (2) Male Pipe |  Y-OFS-2601-F - Tee (1) (2) Male OFS (3) Male Pipe | (520401)  Y-OFS-2603-F - Tee (1)(2)(3) Male OFS Union |  Y-OFS-2605-F - Tee (1)(3) Male OFS (2) Male Pipe |
| (520501)  Y-OFS-2650-F - Cross (1)(2)(3)(4) Male OFS Union | (520601)  Y-OFS-2700 - Str. (1) Male OFS (2) OFS Bulkhead |  Y-OFS-2700-LN - Str. (1) Male OFS (2) OFS Bulkhead with Locknut |  Y-OFS-2701-F - 90° (1) Male OFS (2) OFS Bulkhead |  Y-OFS-2701-F-LN - 90° (1) Male OFS (2) OFS Bulkhead with Locknut |  Y-OFS-2702-F - 45° (1) Male OFS (2) OFS Bulkhead |

IMPORT O-RING FACE SEAL (continued)

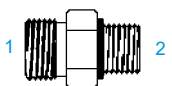
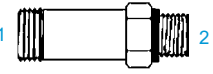
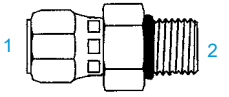
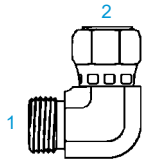
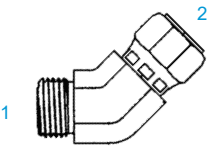
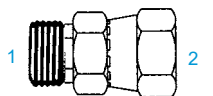
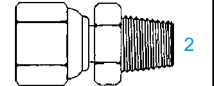
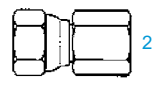
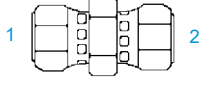
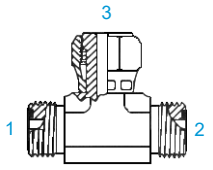
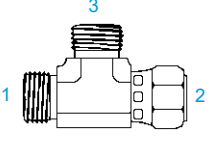
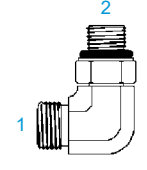
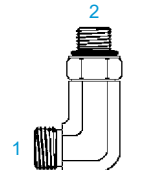
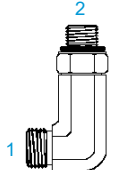
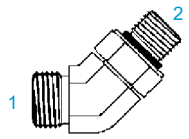
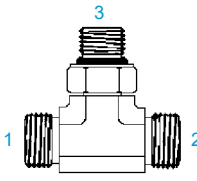
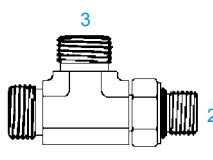
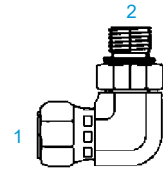
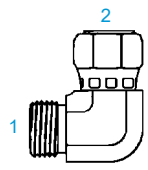
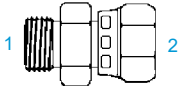
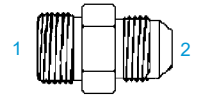
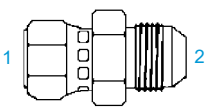
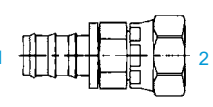
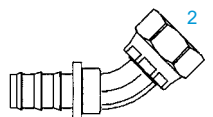
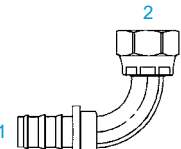
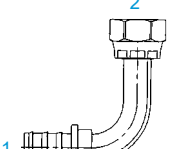
O-RING FACE SEAL

| | | | | | |
|--|--|---|---|---|--|
|  <p>Y-OFS-2702-F-LN - 45° (1) Male OFS (2) OFS Bulkhead with Locknut</p> |  <p>Y-OFS-2703-F - Tee (1)(2) Male OFS (3) OFS Bulkhead</p> |  <p>Y-OFS-2703-F-LN - Tee (1)(2) Male OFS (3) OFS Bulkhead with Locknut</p> |  <p>Y-OFS-2704-F - Tee (1)(3) Male OFS (2) OFS Bulkhead</p> |  <p>Y-OFS-2704-F-LN - Tee (1)(3) Male OFS (2) OFS Bulkhead with Locknut</p> |  <p>Y-OFS-2705-LN - Str. (1) Male OFS Bulkhead w/locknut (2) Fem. Pipe</p> |
|  <p>Y-OFS-2706-LN - Str. (1) Male OFS Bulkhead w/locknut (2) Male Pipe</p> |  <p>Y-OFS-2711-LN - Str. (1) OFS Bulkhead with Locknut (2) Male O-Ring</p> |  <p>Y-OFS-4000</p> |  <p>Y-OFS-4000-V</p> |  <p>Y-OFS-6400-O - Str. (1) Male OFS (2) Male O-Ring</p> |  <p>Y-OFS-6400-L-O - Str. (1) Male OFS (2) Male O-Ring-Long</p> |
|  <p>OFS-6402-O - Str. (1) Fem. OFS Swivel (2) Male O-Ring</p> |  <p>Y-OFS-6500-F - 90° (1) Male OFS (2) Fem. OFS Swivel</p> |  <p>Y-OFS-6502-F - 45° (1) Male OFS (2) Fem. OFS Swivel</p> |  <p>Y-OFS-6504 - Str. (1) Male OFS (2) Fem. OFS Swivel</p> |  <p>Y-OFS-6505 - Str. (1) Fem. OFS Swivel (2) Male Pipe</p> |  <p>Y-OFS-6514 - Str. (1) Fem. OFS Swivel (2) Fem. O-Ring</p> |
|  <p>Y-OFS-6565 - Str. (1)(2) Fem. OFS Swivel</p> |  <p>Y-OFS-6600-F - Tee (1)(2) Male OFS (3) Fem. OFS Swivel</p> |  <p>Y-OFS-6602-F - Tee (1)(3) Male OFS (2) Fem. OFS Swivel</p> |  <p>Y-OFS-6801-F-NWO - 90° (1) Male OFS (2) Adj. O-Ring</p> |  <p>Y-OFS-6801-F-L-NWO - 90° (1) Male OFS (2) Adj. O-Ring-Long</p> |  <p>Y-OFS-6801-F-LL-NWO - 90° (1) Male OFS (2) Adj. O-Ring-Ex. Long</p> |
|  <p>Y-OFS-6802-F-NWO - 45° (1) Male OFS (2) Adj. O-Ring</p> |  <p>Y-OFS-6803-F-NWO - Tee (1)(2) Male OFS (3) Adj. O-Ring</p> |  <p>Y-OFS-6804-F-NWO - Tee (1)(3) Male OFS (2) Adj. O-Ring</p> |  <p>Y-OFS-6809-F-NWO - 90° (1) Fem. OFS Swivel (2) Adj. O-Ring</p> |  <p>Y-OFS-FJIC-6500-F - 90° (1) Male OFS (2) Fem. JIC Swivel</p> |  <p>Y-OFS-FJIC-6504 - Str. (1) Male OFS (2) Fem. JIC Swivel</p> |
|  <p>Y-OFS-MJIC-2403 - Str. (1) Male OFS (2) Male JIC</p> |  <p>Y-OFS-MJIC-6504 - Str. (1) Fem. OFS Swivel (2) Male JIC</p> |  <p>Y-OFS-SPO-2287 - Str. (1) Steel Push On (2) Fem. OFS Swivel</p> |  <p>Y-OFS-SPO-2305 - 45° (1) Steel Push On (2) Fem. OFS Swivel</p> |  <p>Y-OFS-SPO-2306 - 90° (1) Steel Push On (2) Fem. OFS Swivel</p> |  <p>Y-OFS-SPO-2306-LL - 90° (1) Steel Push On (2) Fem. OFS Swivel - Ex. Long</p> |

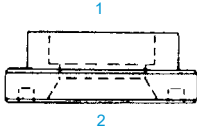
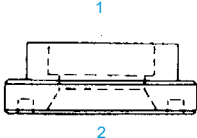
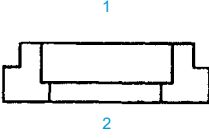
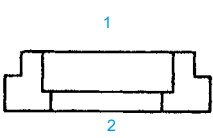
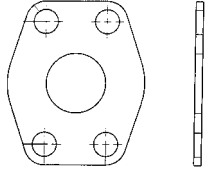
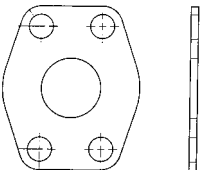
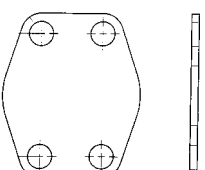
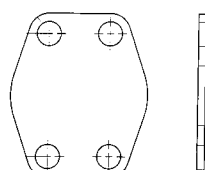
Import Flange Adapters

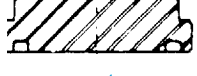
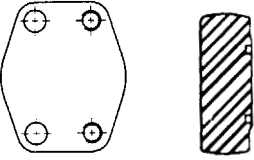
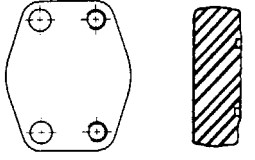
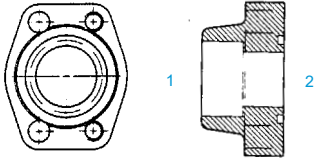
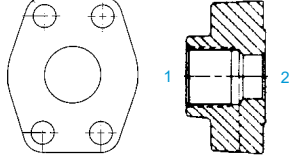
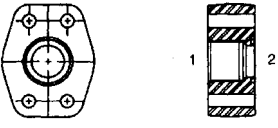
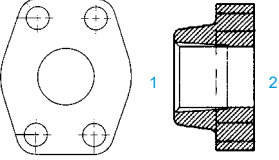
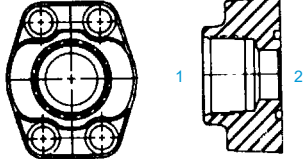
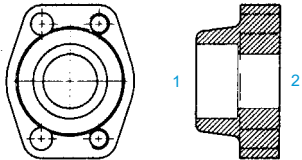
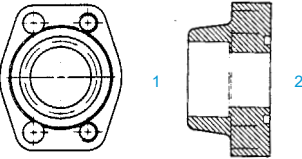
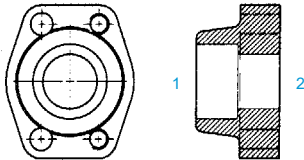

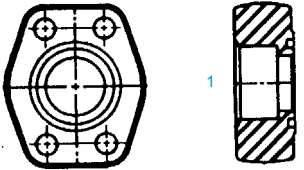
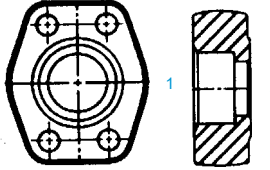
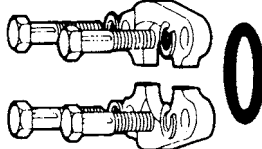
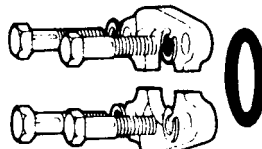
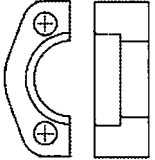
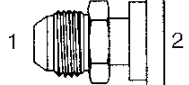
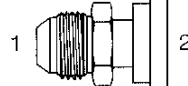
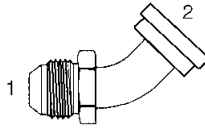
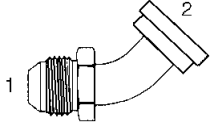
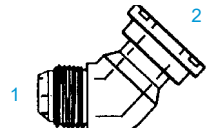
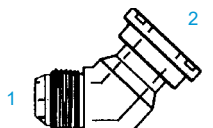
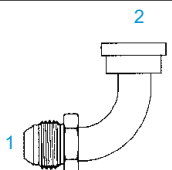
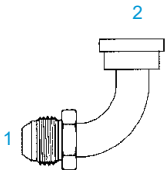
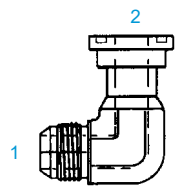
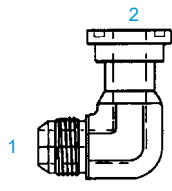





| | | | |
|---|---|--|--|
|  <p>Y-SF-3300-61 (1) (2) Braze Flange Code 61</p> |  <p>Y-SF-3300-62 (1) (2) Braze Flange Code 62</p> |  <p>Y-SF-3301-61 (1) Braze (2) Flat Face Flange Code 61</p> |  <p>Y-SF-3301-62 (1) Braze (2) Flat Face Flange Code 62</p> |
|  <p>Y-SF-61-CP Connector Plate Code 61</p> |  <p>Y-SF-62-CP Connector Plate Code 62</p> |  <p>Y-SF-61-SP Shipping Plate Code 61</p> |  <p>Y-SF-62-SP Shipping Plate Code 62</p> |
|  <p>Y-SF-P61 (1) Flange Plug</p> |  <p>Y-SF-P62 (1) Flange Plug</p> |  <p>Y-SF-W36K Blanking Flange - with O-ring Groove Drilled Holes - O-Ring Kit Code 61</p> |  <p>Y-SF-W38K Blanking Flange - with O-ring Groove Drilled Holes - O-Ring Kit Code 62</p> |
|  <p>Y-SF-W43K (1) Fem. Pipe (2) Flange - with O-ring Groove Drilled Holes - O-Ring Kit Code 61</p> |  <p>Y-SF-W104 (1) Fem. NPTF Thread (2) Flange - Tapped Holes Companion to Y-SF-W43K Code 61</p> |  <p>Y-SF-W44K (1) Fem. Pipe (2) Flange - with O-ring Groove Drilled Holes - O-Ring Kit Code 62</p> |  <p>Y-SF-W45 (1) Fem. Pipe (2) Flange - Tapped Holes Companion to Y-SF-W44K Code 62</p> |
|  <p>Y-SF-W46K (1) SAE Internal Straight Thread (2) Flange - with O-ring Groove Drilled Holes - O-Ring Kit Code 61</p> |  <p>Y-SF-W106 (1) SAE Internal Straight Thread (2) Flange - Tapped Holes Companion to Y-SF-W46K Code 61</p> |  <p>Y-SF-W48K (1) SAE Internal Straight Thread (2) Flange - with O-ring Groove Drilled Holes - O-Ring Kit Code 62</p> |  <p>Y-SF-W49 (1) SAE Internal Straight Thread (2) Flange - Tapped Holes Companion to Y-SF-W48K Code 62</p> |

| | | | |
|--|---|---|---|
|  <p>Y-SF-W4K (1) Flat Socket Weld Pipe (2) Flange - with O-ring Groove Drilled Holes - O-Ring Kit Code 61</p> |  <p>Y-SF-W61 (1) Flat Socket Weld Pipe (2) Flange - Tapped Holes Companion to Y-SF-W4K Code 61</p> |  <p>Y-SFK-61 Split Flange Kit Code 61</p> |  <p>Y-SFK-62 Split Flange Kit Code 62</p> |
|  <p>Y-SFK-62-CAT Caterpillar Flange Kit Comes with bolts and O-Ring Code 62</p> |  <p>Y-1700-61 - Str. (1) Male 37° (2) O-Ring Flange Code 61</p> |  <p>Y-1700-62 - Str. (1) Male 37° (2) O-Ring Flange Code 62</p> |  <p>Y-1703-61 - 45° Bent Tube (1) Male 37° (2) O-Ring Flange Code 61</p> |
|  <p>Y-1703-62 - 45° Bent Tube (1) Male 37° (2) O-Ring Flange Code 62</p> |  <p>Y-1703-F-61 - 45° Forged (1) Male 37° (2) O-Ring Flange Code 61</p> |  <p>Y-1703-F-62 - 45° Forged (1) Male 37° (2) O-Ring Flange Code 62</p> |  <p>Y-1704-61 - 90° Bent Tube (1) Male 37° (2) O-Ring Flange Code 61</p> |
|  <p>Y-1704-62 - 90° Bent Tube (1) Male 37° (2) O-Ring Flange Code 62</p> |  <p>Y-1704-F-61 - 90° Forged (1) Male 37° (2) O-Ring Flange Code 61</p> |  <p>Y-1704-F-62 - 90° Forged (1) Male 37° (2) O-Ring Flange Code 62</p> | |

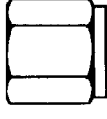
IMPORT STAINLESS STEEL ADAPTERS

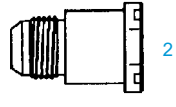
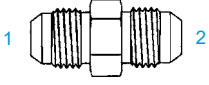
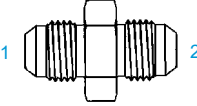
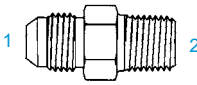
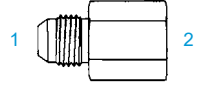
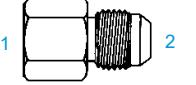

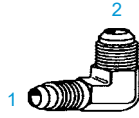
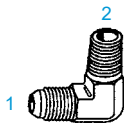
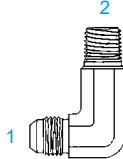
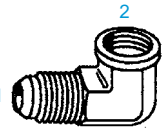
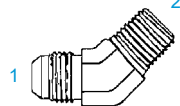
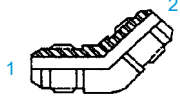
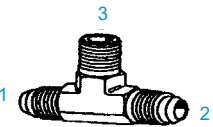
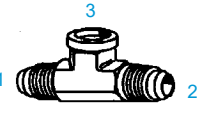
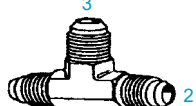
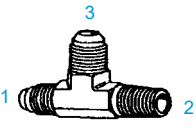
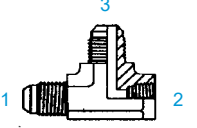
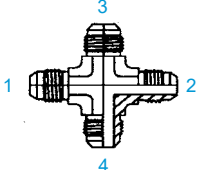
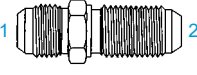
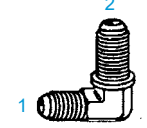
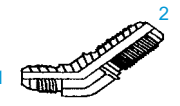
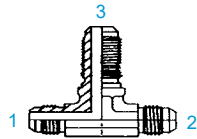
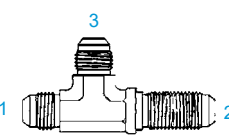
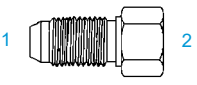





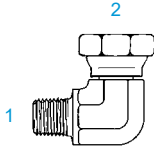
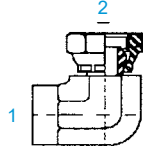
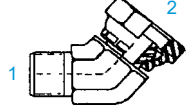

TUBE FITTINGS, J.I.C. - S.A.E.

| Dash Number | 2 | 3 | 4 | 5 | 6 | 8 | 10 | 12 | 14 | 16 | 20 | 24 | 32 |
|------------------|---------|--------|---------|--------|--------|--------|--------|-----------|-----------|-----------|--------------|--------------|----------|
| Tube O.D. | 1/8 | 3/16 | 1/4 | 5/16 | 3/8 | 1/2 | 5/8 | 3/4 | 7/8 | 1 | 1-1/4 | 1-1/2 | 2 |
| Straight Thread | 5/16-24 | 3/8-24 | 7/16-20 | 1/2-20 | 5/8-18 | 3/4-16 | 7/8-14 | 1 1/16-12 | 1 3/16-12 | 1 5/16-12 | 1 5/8-12 | 1 7/8-12 | 2 1/2-12 |
| Pipe Thread Std. | 1/8-27 | 1/8-27 | 1/8-27 | 1/8-27 | 1/4-18 | 3/8-18 | 1/2-14 | 3/4-14 | 3/4-14 | 1-11 1/2 | 1 1/4-11 1/2 | 1 1/2-11 1/2 | 2-11 1/2 |

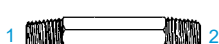
| | | | | |
|--|---|---|---|---|
|  <p>Y-SS-0304-C Cap Nut</p> |  <p>Y-SS-0306 Bulkhead Lock Nut</p> |  <p>Y-SS-0318 37° Nut</p> |  <p>Y-SS-0319 37° Sleeve</p> |  <p>Y-SS-1700-61 - Str. (1) Male 37° (2) O-Ring Flange</p> |
|  <p>Y-SS-2403 - Str. (1)(2) Male 37° Union</p> |  <p>Y-SS-2403-LH - Str. (1)(2) Male 37° Union Large Hex</p> |  <p>Y-SS-2404 - Str. (1) Male 37° (2) Male Pipe</p> |  <p>Y-SS-2405 - Str. (1) Male 37° (2) Fem. Pipe</p> |  <p>Y-SS-2406 - Str. Reducer & Expander (1) Fem. 37° (2) Male 37°</p> |
|  <p>Y-SS-2408 (1) Male 37° Plug</p> |  <p>Y-SS-2500 - 90° (1)(2) Male 37°</p> |  <p>Y-SS-2501 - 90° (1) Male 37° (2) Male Pipe</p> |  <p>Y-SS-2501-L - 90° (1) Male 37° (2) Male Pipe Long</p> |  <p>Y-SS-2502 - 90° (1) Male 37° (2) Fem. Pipe</p> |
|  <p>Y-SS-2503 - 45° (1) Male 37° (2) Male Pipe</p> |  <p>Y-SS-2504 - 45° (1)(2) Male 37°</p> |  <p>Y-SS-2601 - Tee (1)(2) Male 37° (3) Male Pipe</p> |  <p>Y-SS-2602 - Tee (1)(2) Male 37° (3) Fem. Pipe</p> |  <p>Y-SS-2603 - Tee (1)(2)(3) Male 37°</p> |
|  <p>Y-SS-2605 - Tee (1)(3) Male 37° (2) Male Pipe</p> |  <p>Y-SS-2606 - Tee (1)(3) Male 37° (2) Fem. Pipe</p> |  <p>Y-SS-2650 - Cross (1)(2)(3)(4) Male 37°</p> |  <p>Y-SS-2700 - Str. (1) Male 37° (2) Male 37° Bulkhead</p> |  <p>Y-SS-2701 - 90° (1) Male 37° (2) Male 37° Bulkhead</p> |
|  <p>Y-SS-2702 - 45° (1) Male 37° (2) Male 37° Bulkhead</p> |  <p>Y-SS-2703 - Tee (1)(2) Male 37° (2) Male 37° Bulkhead</p> |  <p>Y-SS-2704 - Tee (1)(3) Male 37° (2) Male 37° Bulkhead</p> |  <p>Y-SS-2705 - Str. (1) Male 37° Bulkhead (2) Fem. Pipe</p> |  <p>Y-SS-2706 - Str. (1) Male 37° Bulkhead (2) Male Pipe</p> |

PIPE FITTINGS



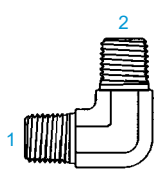
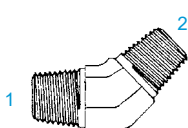
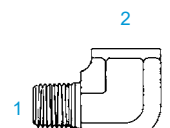
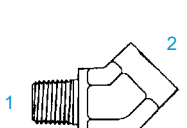
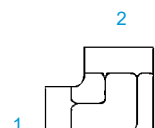
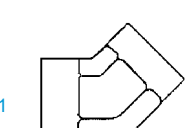
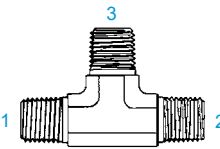
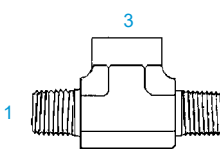
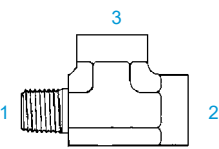
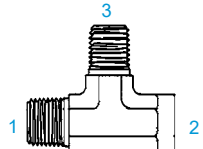
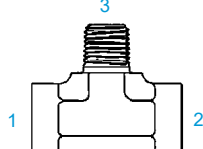
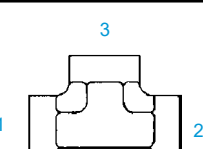
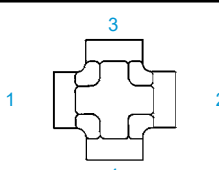







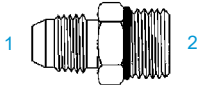
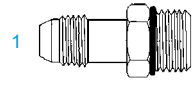
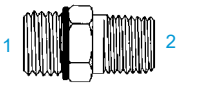
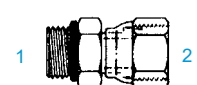

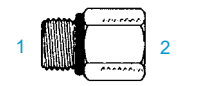



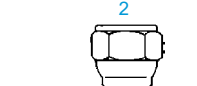

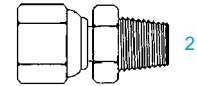

| Dash Number | 2 | 4 | 6 | 8 | 12 | 16 | 20 | 24 | 32 |
|---------------------------------|------|------|------|------|------|-------|--------|--------|-------|
| Pipe Thread Std. NPSM - NPTF | ½-27 | ¼-18 | ¾-18 | ½-14 | ¾-14 | 1-11½ | 1¼-11½ | 1½-11½ | 2-11½ |

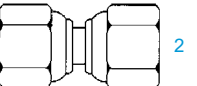
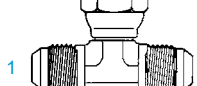
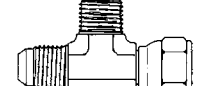
| | | | | |
|---|---|--|---|--|
|  <p>Y-SS-1404 - Str. (1) Male Pipe (2) Fem. Pipe Swivel</p> |  <p>Y-SS-1405 - Str. (1) Fem. Pipe (2) Fem. Pipe Swivel</p> |  <p>Y-SS-1501 - 90° (1) Male Pipe (2) Fem. Pipe Swivel</p> |  <p>Y-SS-1502 - 90° (1) Fem. Pipe (2) Fem. Pipe Swivel</p> |  <p>Y-SS-1503 - 45° (1) Male Pipe (2) Fem. Pipe Swivel</p> |
|  <p>Y-SS-5000 - Str. (1)(2) Fem. Pipe</p> |  <p>Y-SS-5404 - Str. (1)(2) Male Pipe</p> |  <p>Y-SS-5404-N - Str. Nipple (1)(2) Male Pipe</p> |  <p>Y-SS-5405 - Str. Reducer & Expander (1) Male Pipe (2) Fem. Pipe</p> |  <p>Y-SS-5406 - Str. Bushing (1) Male Pipe (2) Fem. Pipe</p> |
|  <p>Y-SS-5406-C (1) Pipe Cap</p> |  <p>Y-SS-5406-HHP (1) Hollow Hex Pipe Plug</p> |  <p>Y-SS-5406-P (1) Pipe Plug</p> |  <p>Y-SS-5406-SHP (1) Square Head Plug</p> |  <p>Y-SS-5500 - 90° (1)(2) Male Pipe</p> |
|  <p>Y-SS-5501 - 45° (1)(2) Male Pipe</p> |  <p>Y-SS-5502 - 90° (1) Male Pipe (2) Fem. Pipe</p> |  <p>Y-SS-5503 - 45° (1) Male Pipe (2) Fem. Pipe</p> |  <p>Y-SS-5504 - 90° (1)(2) Fem. Pipe</p> |  <p>Y-SS-5505 - 45° (1)(2) Fem. Pipe</p> |
|  <p>Y-SS-5600 - Tee (1)(2)(3) Male Pipe</p> |  <p>Y-SS-5601 - Tee (1)(2) Male Pipe (3) Fem. Pipe</p> |  <p>Y-SS-5602 - Tee (1) Male Pipe (2)(3) Fem. Pipe</p> |  <p>Y-SS-5603 - Tee (1)(3) Male Pipe (2) Fem. Pipe</p> |  <p>Y-SS-5604 - Tee (1)(2) Fem. Pipe (3) Male Pipe</p> |
|  <p>Y-SS-5605 - Tee (1)(2)(3) Fem. Pipe</p> |  <p>Y-SS-5652 - Cross (1)(2)(3)(4) Fem. Pipe</p> | | | |

STAINLESS STEEL

ADJUSTABLE & O-RING FITTINGS

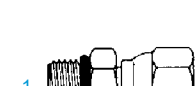
(Refer to Tube Fittings, "JIC-SAE" Chart for sizes)

| | | | | |
|---|---|---|---|---|
|  <p>Y-SS-6400-O - Str. (1) Male 37° (2) Male O-Ring</p> |  <p>Y-SS-6400-L-O - Str. (1) Male 37° - Long (2) Male O-Ring</p> |  <p>Y-SS-6401-O - Str. (1) Male O-Ring (2) Male Pipe</p> |  <p>Y-SS-6402-O - Str. (1) Male O-Ring (2) 37° Fem. Swivel</p> |  <p>Y-SS-6404 - Str. (1) Fem. O-Ring (2) Male Pipe</p> |
|  <p>Y-SS-6405-O - Str. (1) Male O-Ring (2) Fem. Pipe</p> |  <p>Y-SS-6408-O - Str. (1) Male O-Ring Plug</p> |  <p>Y-SS-6408-HHP-O Hollow Hex O-Ring Plug</p> |  <p>Y-SS-6410-O - Str. (1) Male O-Ring (2) Fem. O-Ring</p> |  <p>Y-SS-6464-NWO - Str. (1) Male O-Ring (2) Adj. O-Ring</p> |
|  <p>Y-SS-6500 - 90° (1) Male 37° (2) 37° Fem. Swivel</p> |  <p>Y-SS-6501 - 90° (1) 37° Fem. Swivel (2) Male Pipe</p> |  <p>Y-SS-6502 - 45° (1) Male 37° (2) 37° Fem. Swivel</p> |  <p>Y-SS-6503 - 90° (1) 37° Fem. Swivel (2) Fem. Pipe</p> |  <p>Y-SS-6504 - Str. (1) Male 37° (2) 37° Fem. Swivel</p> |
|  <p>Y-SS-6505 - Str. (1) 37° Fem. Swivel (2) Male Pipe</p> |  <p>Y-SS-6506 - Str. (1) 37° Fem. Swivel (2) Fem. Pipe</p> |  <p>Y-SS-6565 - Str. (1)(2) 37° Fem. Swivel</p> |  <p>Y-SS-6600 - Tee (1)(2) Male 37° (3) 37° Fem. Swivel</p> |  <p>Y-SS-6602 - Tee (1)(3) Male 37° (2) 37° Fem. Swivel</p> |
|  <p>Y-SS-6606 - Tee (1)(2)(3) 37° Fem. Swivel</p> |  <p>Y-SS-6801-NWO - 90° (1) Male 37° (2) Adj. O-Ring</p> |  <p>Y-SS-6801-L-NWO - 90° (1) Male 37° (2) Adj. O-Ring - Long</p> |  <p>Y-SS-6802-NWO - 45° (1) Male 37° (2) Adj. O-Ring</p> |  <p>Y-SS-6803-NWO - Tee (1)(2) Male 37° (3) Adj. O-Ring</p> |
|  <p>Y-SS-6804-NWO - Tee (1)(3) Male 37° (2) Adj. O-Ring</p> |  <p>Y-SS-6900-O - Str. (1) Male O-Ring (2) Fem. Pipe Swivel</p> |  <p>Y-SS-6901-NWO - 90° (1) Adj. O-Ring (2) Fem. Pipe Swivel</p> | | |



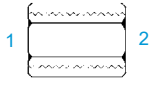
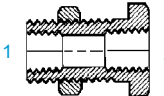
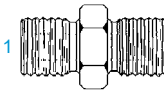
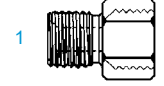
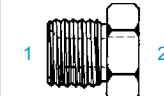
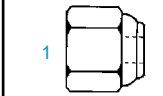
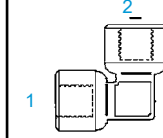
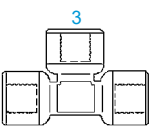
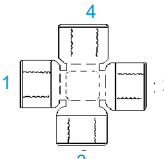
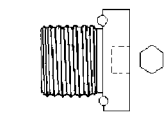
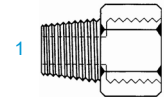

STAINLESS STEEL

BRASS FITTING & ADAPTERS

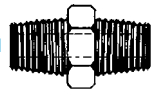

BRASS BRITISH PARALLEL PIPE FITTINGS

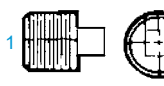
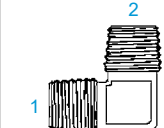
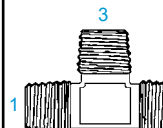
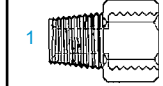
| | | | | | | |
|---|--|---|---|---|--|--|
|  <p>B-BPP-5000 - Str. (1)(2) Fem. BPP</p> |  <p>B-BPP-5000-BH - Str. (1)(2) Fem. BPP w/ Lock Nut</p> |  <p>B-BPP-5404 - Str. (1) (2) Male BPP</p> |  <p>B-BPP-5405 - Str. (1) Male BPP (2) Fem. BPP</p> |  <p>B-BPP-5406 - Bushing (1) Male BPP (2) Fem. BPP</p> |  <p>B-BPP-5406-C (1) BPP Cap</p> |  <p>B-BPP-5504 - 90° (1)(2) Fem. BPP</p> |
|  <p>B-BPP-5605 - Tee (1)(2)(3) Fem. BPP</p> |  <p>B-BPP-5652 - Cross (1)(2)(3)(4) Fem. BPP</p> |  <p>B-BPP-6408-HHP-EO (1) BPP Hollow Hex Plug</p> |  <p>B-BPP-MP-5405 - Str. (1) Male NPT Pipe (2) Fem. BPP</p> | | | |

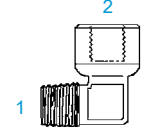
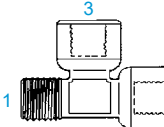
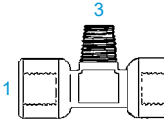
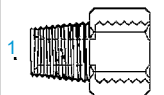
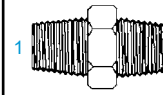



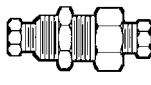
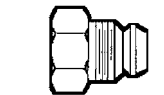
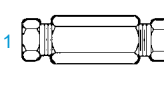
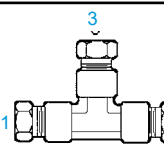
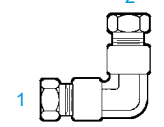
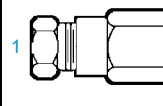
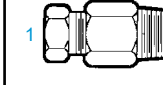
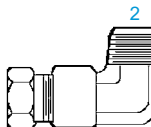
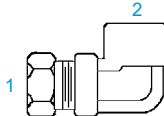
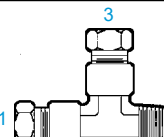
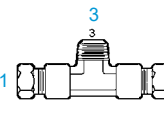
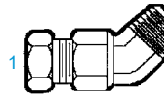
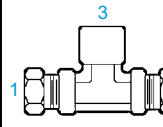



BRASS BRITISH STANDARD TAPER FITTINGS

| | | | | | | |
|--|---|--|---|--|---|---|
|  <p>B-BST-5404 - Str. (1)(2) Male BST</p> |  <p>B-BST-5406-HHP (1) BST Hollow Hex Plug</p> |  <p>B-BST-5406-P (1) BST Plug</p> |  <p>B-BST-5406-SHP (1) BST Square Head Plug</p> |  <p>B-BST-5500 - 90° (1)(2) Male BST</p> |  <p>B-BST-5600 - Tee (1)(2)(3) Male BST</p> |  <p>B-BST-FBPP-5405 - Str. (1) Male BST (2) Fem. BPP</p> |
|  <p>B-BST-FBPP-5406 - Str. Bushing (1) Male BST (2) Fem. BPP</p> |  <p>B-BST-FBPP-5502-90° (1) Male BST (2) Fem. BPP</p> |  <p>B-BST-FBPP-5602 - Tee (1) Male BPP (2)(3) Fem. BPP</p> |  <p>B-BST-FBPP-5604 - Tee (1) (2) Fem. BPP (3) Male BST</p> |  <p>B-BST-FP-5405 - Str. (1) Male BST (2) Fem. Pipe</p> |  <p>B-BST-MP-5404 - Str. (1) Male BST (2) Male Pipe</p> | |

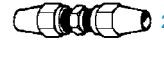

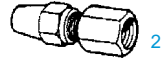
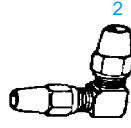

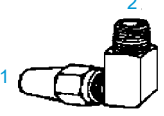
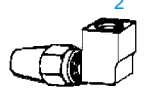
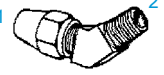
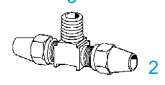
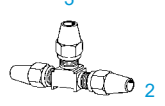
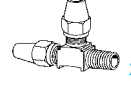



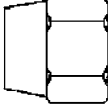

BRASS IMPERIAL HIGH DUTY FITTINGS

| | | | | | | |
|---|---|---|---|--|---|---|
|  <p>B-IE-72-LB Bulkhead Union (1) (2) Tube</p> |  <p>B-IE-81-LB Nut</p> |  <p>B-IE-82-LB - Union (1) (2) Tube</p> |  <p>B-IE-84-LB - Union Tee (1) (2) (3) Tube</p> |  <p>B-IE-85-LB - Union Elbow (1) (2) Tube</p> |  <p>B-IE-86-LB - Str. (1) Tube (2) Fem. Pipe</p> |  <p>B-IE-88-LB - Connector (1) Tube (2) Male Pipe</p> |
|  <p>B-IE-89-LB - 90° (1) Tube (2) Male Pipe</p> |  <p>B-IE-90-LB - 90° (1) Tube (2) Fem. Pipe</p> |  <p>B-IE-91-LB - Tee (1) (3) Tube (2) Male Pipe</p> |  <p>B-IE-92-LB - Tee (1) (2) Tube (3) Male Pipe</p> |  <p>B-IE-94-LB - 45° (1) Tube (2) Male Pipe</p> |  <p>B-IE-95-LB - Tee (1) (2) Tube (3) Fem. Pipe</p> |  <p>B-IE-99-LB (1) Plug</p> |

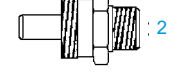
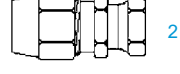

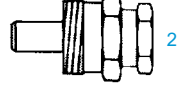
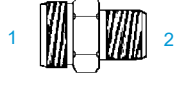
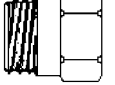
BRASS AIR BRAKE - COPPER TUBING

| | | | | | | |
|---|--|--|--|--|---|---|
|  BAB-C-0318 - Nut |  BAB-C-0319 - Sleeve |  BAB-C-2403 - Str. (1)(2) Air Brake Union |  BAB-C-2404 - Str (1) Air Brake (2) Male Pipe |  BAB-C-2405 - Str. (1) Air Brake (2) Fem. Pipe |  BAB-C-2500 - 90° (1)(2) Air Brake |  BAB-C-2501 - 90° (1) Air Brake (3) Male Pipe |
|  BAB-C-2501-L - 90° (1) Air Brake (2) Male Pipe - Long |  BAB-C-2502 - 90° (1) Air Brake (2) Fem. Pipe |  BAB-C-2503 - 45° (1) Air Brake (2) Male Pipe |  BAB-C-2601 - Tee (1) (2) Air Brake (3) Male Pipe |  BAB-C-2603 - Tee (1)(2)(3) Air Brake |  BAB-C-2605 - Tee (1)(3) Air Brake (2) Male Pipe |  BAB-C-2700-LN - Str. (1) Air Brake (2) Bulkhead Air Brake |

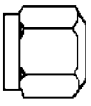
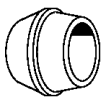
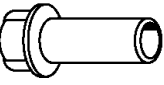

BRASS AIR BRAKE - HOSE END

| | | | | | | |
|---|---|---|---|--|--|--|
|  BAB-HE-0318 - Nut |  BAB-HE-0319 - Sleeve |  BAB-HE-2403 - Str. (1)(2) Hose End Union |  BAB-HE-2403-BO - Str. Body Only (1)(2) Hose End Union |  BAB-HE-2404 - Str. (1) Hose End (2) Male Pipe |  BAB-HE-2404-BO - Str. (1) Hose End (2) Male Pipe |  BAB-HE-2405 - Str. (1) Hose End (2) Fem. Air Brake Swivel |
|  BAB-HE-2405-A - Str. (1) Hose End (2) Fem. Air Brake Swivel w/ Adapter |  BAB-HE-2405-BO - Str. Body Only (1) Hose End (2) Fem. Air Brake Swivel |  BAB-HE-2411 - Str. (1) Male Air Brake (2) Male Pipe |  BAB-HE-SG-0318 - Nut for Spring Guard |  BAB-HE-SG-0318A - Nut w/ Spring Guard |  BAB-HE-SG - Spring Guard |  BAB-HE-SG-2404 -Str. (1) Hose End w/Spring Guard (2) Male Pipe |

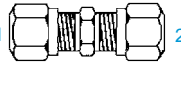
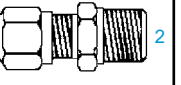
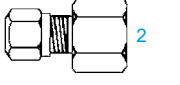
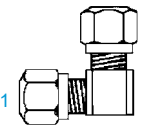
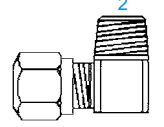
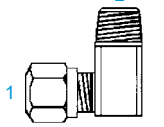
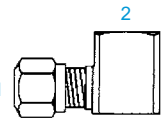
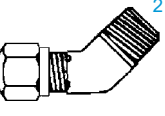
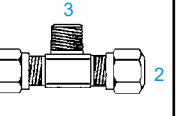
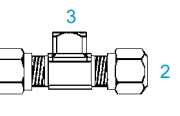
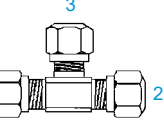
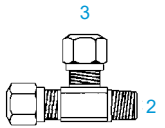
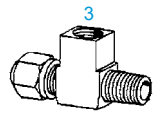
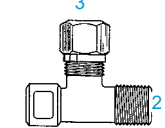
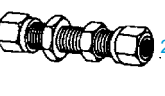
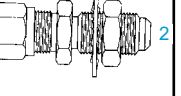

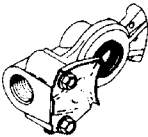

BRASS AIR BRAKE - NYLON TUBING

| | | | | | | |
|---|--|---|---|--|---|--|
|  BAB-N-0318 - Nut |  BAB-N-0319 - Sleeve |  BAB-N-0363 - Insert |  BAB-N-0370 - Gauge Ring |  BAB-N-2403 - Str. (1)(2) Air Brake Union |  BAB-N-2404 - Str. (1) Air Brake (2) Male Pipe |  BAB-N-2405 - Str. (1) Air Brake (2) Fem. Pipe |
|  BAB-N-2500 - 90° (1)(2) Air Brake |  BAB-N-2501 - 90° (1) Air Brake (2) Male Pipe |  BAB-N-2501-L - 90° (1) Air Brake (2) Male Pipe Long |  BAB-N-2502 - 90° (1) Air Brake (2) Fem. Pipe |  BAB-N-2503 - 45° (1) Air Brake (2) Male Pipe |  BAB-N-2601 - Tee (1)(2) Air Brake (3) Male Pipe |  BAB-N-2602 - Tee (1) (2) Air Brake (3) Fem. Pipe |
|  BAB-N-2603 - Tee (1)(2)(3) Air Brake Union |  BAB-N-2605 - Tee (1) (3) Air Brake (2) Male Pipe |  BAB-N-2611 - Tee (1) Air Brake (2) Male Pipe (3) Fem. Pipe |  BAB-N-2613 (1) Air Brake (2) Male Pipe (3) Fem. Pipe |  BAB-N-2700-LN - Str. (1) Air Brake (2) Bulkhead Air Brake |  BAB-N-BF-2700-LN - Str. (1) Air Brake (2) Bulkhead Male 45° | |

BRASS AIR BRAKE ACCESSORIES

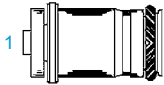

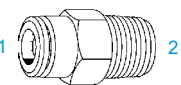
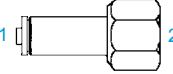
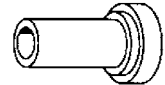
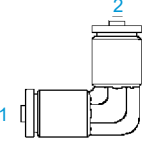
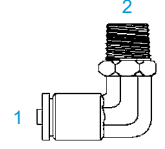
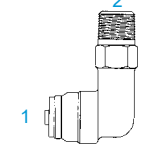
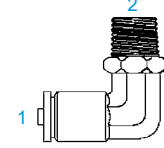
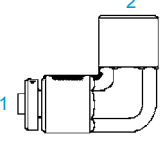
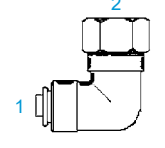
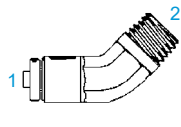
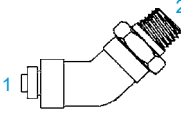
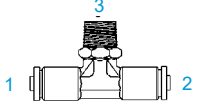
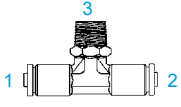
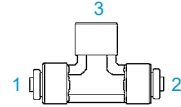
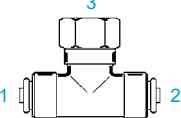
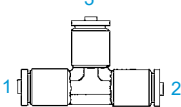
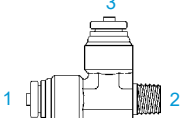
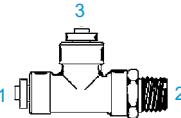

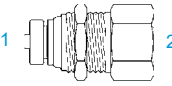
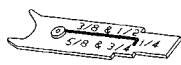

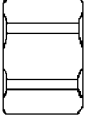
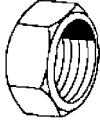
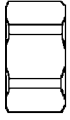
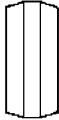

| | | | | | | |
|--|---|--|--|--|--|--|
|  <p>BAB-GLADHAND COUPLER Universal Meets MS35746-1</p> |  <p>BAB-GLADHAND SEAL Universal</p> | | | | | |
|--|---|--|--|--|--|--|

BRASS PUSH CONNECT - DOT APPROVED

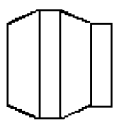
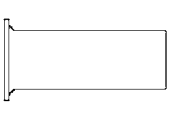
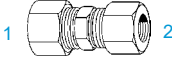
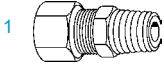

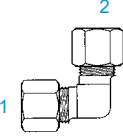
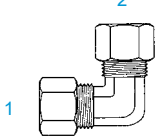
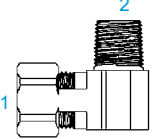
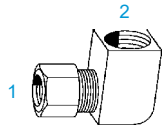
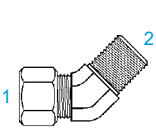
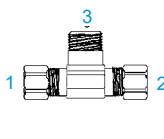
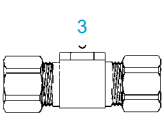
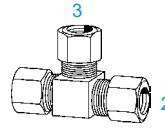
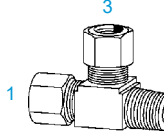

| | | | | | | |
|---|--|---|--|---|---|---|
|  <p>BPC-DOT-2161 - Encapsulated Cartridge (1) Tube</p> |  <p>BPC-DOT-2403 - Union (1)(2) Union</p> |  <p>BPC-DOT-2404 - Str. (1) Tube (2) Male Pipe</p> |  <p>BPC-DOT-2405 - Str. (1) Tube (2) Fem. Pipe</p> |  <p>BPC-DOT-2408 - Str. (1) Plug</p> |  <p>BPC-DOT-2500 - 90° (1)(2) Tube Union</p> |  <p>BPC-DOT-2501 - 90° (1) Tube (2) Male Pipe</p> |
|  <p>BPC-DOT-2501-L - 90° (1) Tube (2) Male Pipe - Long</p> |  <p>BPC-DOT-2501-S - 90° (1) Tube (2) Male Pipe Swivel</p> |  <p>BPC-DOT-2502 - 90° (1) Tube (2) Fem. Pipe</p> |  <p>BPC-DOT-2502-S - 90° (1) Tube (2) Fem. Pipe Swivel</p> |  <p>BPC-DOT-2503 - 45° (1) Male Tube (2) Male Pipe</p> |  <p>BPC-DOT-2503-S - 45° (1) Male Tube (2) Male Pipe Swivel</p> |  <p>BPC-DOT-2601 - Tee (1)(2) Tube (3) Male Pipe</p> |
|  <p>BPC-DOT-2601-S - Tee (1)(2) Tube (3) Male Pipe Swivel</p> |  <p>BPC-DOT-2602 - Tee (1)(2) Tube (3) Fem. Pipe</p> |  <p>BPC-DOT-2602-S - Tee (1)(2) Tube (3) Fem. Pipe Swivel</p> |  <p>BPC-DOT-2603 - Tee (1)(2)(3) Tube Union</p> |  <p>BPC-DOT-2605 - Tee (1)(3) Tube (3) Male Pipe</p> |  <p>BPC-DOT-2605-S - Tee (1)(3) Tube (3) Male Pipe Swivel</p> |  <p>BPC-DOT-2700-LN - Str. (1) Tube (2) Bulkhead Tube</p> |
|  <p>BPC-DOT-2705-LN - Str. (1) Bulkhead Tube (2) Fem. Pipe</p> |  <p>BPC-DOT-TOOL Collett Service Tool</p> | | | | | |

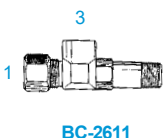
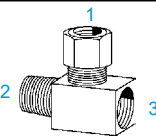
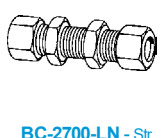
BRASS FITTINGS

BRASS COMPRESSION

| | | | | | | |
|---|---|--|---|--|---|---|
|  BC-0304 - C Cap |  BC-0306 Bulkhead Lock Nut |  BC-0318 Compression Nut |  BC-0319 Compression Sleeve |  BC-0319-DELRIN Compression Sleeve |  BC-0320 Compression Plug |  BC-0363 Brass Insert |
|  BC-2403 - Str. (1)(2) Compression Union |  BC-2404 - Str. (1) Compression (2) Male Pipe |  BC-2404-CV - Str. (1) Compression (2) Male Pipe Check Valve |  BC-2404-TC - Str. (1) Compression (2) Male Pipe-Drilled thru Tank Connector |  BC-2405 - Str. (1) Compression (2) Fem. Pipe |  BC-2500 - 90° (1)(2) Compression Union |  BC-2500-F - 90° Forged (1)(2) Compression Union |
|  BC-2501 - 90° (1) Compression (2) Male Pipe |  BC-2502 - 90° (1) Compression (2) Fem. Pipe |  BC-2503 - 45° (1) Compression (2) Male Pipe |  BC-2601 - Tee (1)(2) Compression (3) Male Pipe |  BC-2602 - Tee (1)(2) Male Compression (3) Fem. Pipe |  BC-2603 - Tee (1)(2)(3) Compression |  BC-2605 - Tee (1)(3) Compression (2) Male Pipe |
|  BC-2608 - Tee (1) Compression (2) Fem. Pipe (3) Male Pipe |  BC-2611 (1) Compression (2) Male Pipe (3) Fem. Pipe |  BC-2613 - Tee (1) Compression (2) Male Pipe (3) Fem. Pipe |  BC-2700-LN - Str. (1) Compression (2) Bulkhead Compression | | | |



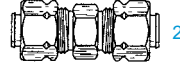
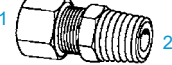
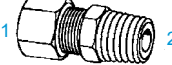
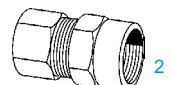
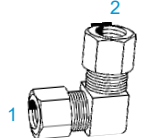
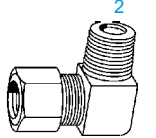
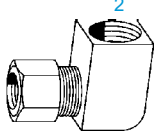
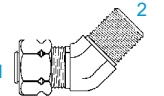
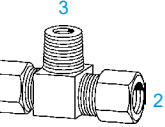
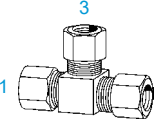
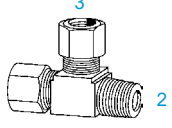
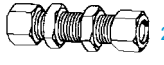



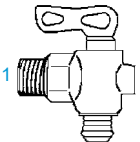
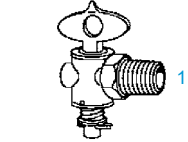
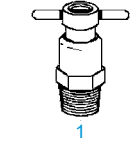
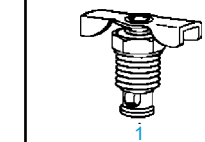
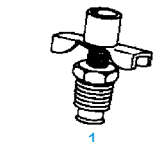
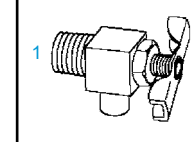
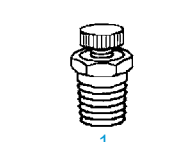



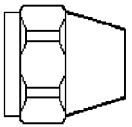
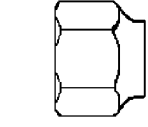
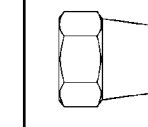
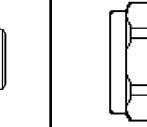
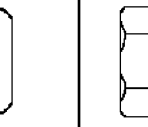
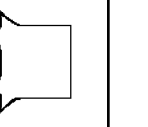
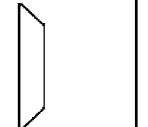
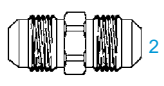
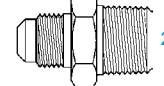
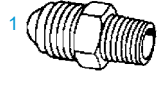
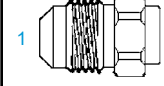
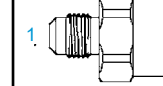
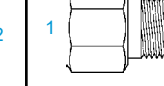
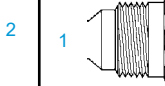
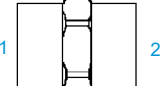

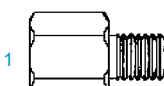

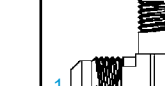
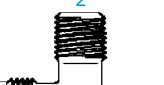
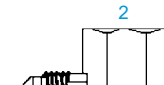

BRASS COMPRESSION SELF ALIGN

| | | | | | | |
|---|---|--|--|---|---|---|
|  BC-SA-0304 - C Cap Nut |  BC-SA-0318 Self Align Nut |  BC-SA-0319 Self Align Sleeve |  BC-SA-0320 - Self Align Captive Nut and Sleeve |  BC-SA-2403 - Str. (1)(2) Compression Union |  BC-SA-2404 - Str. (1) Compression (2) Male Pipe |  BC-SA-2404-CV - Str. (1) Compression (2) Male Check Valve |
|  BC-SA-2405 - Str. (1) Compression (2) Fem. Pipe |  BC-SA-2500 - 90° (1)(2) Compression Union |  BC-SA-2501 - 90° (1) Compression (2) Male Pipe |  BC-SA-2502 - 90° (1) Compression (2) Fem. Pipe |  BC-SA-2503 - 45° (1) Compression (2) Male Pipe |  BC-SA-2601 - Tee (1)(2) Compression (3) Male Pipe |  BC-SA-2603 - Tee (1)(2)(3) Compression Union |
|  BC-SA-2605 - Tee (1)(3) Compression (2) Male Pipe |  BC-SA-2700-LN - Str. (1) Compression (2) Bulkhead Compression | | | | | |

BRASS DRAIN COCKS

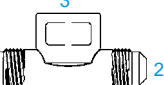
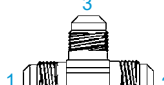
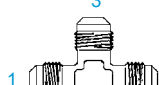
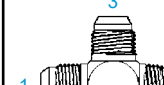

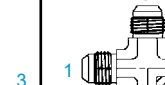
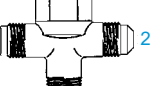
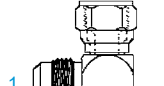
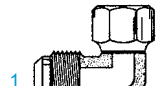

| | | | | | | |
|---|---|---|---|--|---|---|
|  |  |  |  |  |  |  |
| BDC-601 - Str. (30 PSI) (1) Male Pipe | BDC-601-HP - Str. (150 PSI) (1) Male Pipe | BDC-603 - Internal Seat (1) Male Pipe | BDC-604 - External Seat (1) Male Pipe | BDC-606 - External Seat (1) Male Pipe | BDC-607 - Bib Drain (1) Male Pipe | BDC-612 - Air Vent (1) Male Pipe |

BRASS 45° FLARE



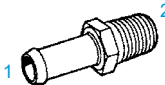
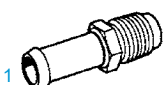
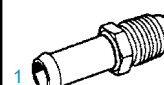
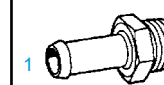







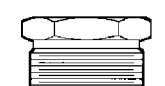

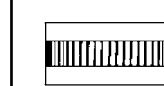
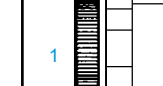
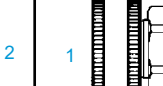

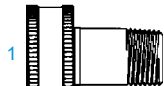

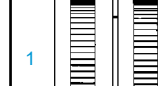
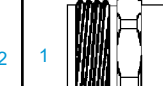

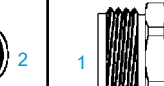
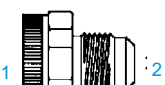
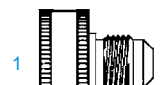
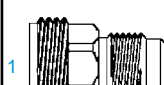
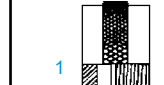
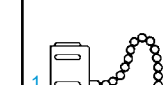

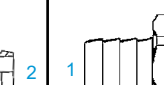
| | | | | | | |
|---|---|---|---|--|---|---|
|  |  |  |  |  |  |  |
| BF-0302 Short Nut | BF-0302-F Forged Short Nut | BF-0304 Standard Nut | BF-0304-C Cap Nut | BF-0304-F Forged Standard Nut | BF-0463 Copper Gasket | BF-0464 Copper Bonnet |
|  |  |  |  |  |  |  |
| BF-2403 - Str. (1)(2) Male 45° Union | BF-2404 - Str. (1) Male 45° (2) Male Pipe | BF-2404-CV - Ball Check Valve (1) Male 45° (2) Male Pipe | BF-2404-SW - Sweat On (1) Male 45° (2) Sweat On | BF-2405 - Str. (1) Male 45° (2) Fem. Pipe | BF-2406 - Str. Reducer & Expander (1) Fem. 45° (2) Male 45° | BF-2408 - Str. (1) Male 45° Plug |
|  |  |  |  |  |  |  |
| BF-2424 - Str. (1)(2) Fem. 45° Union | BF-2424-S - Str. (1)(2) Fem. 45° Swivel Union | BF-2465 - Str. (1) Fem. 45° (2) Male Pipe | BF-2496 - 90° (1) Male 45° (2) Fem. 45° | BF-2500 - 90° (1)(2) Male 45° Union | BF-2500-F - 90° (Forged) (1)(2) Male 45° Union | BF-2501 - 90° (1) Male 45° (2) Male Pipe |
|  |  |  |  |  |  |  |
| BF-2501-F - 90° (Forged) (1) Male 45° (2) Male Pipe | BF-2502 - 90° (1) Male 45° (2) Fem. Pipe | BF-2502-F - 90° (Forged) (1) Male 45° (2) Fem. Pipe | BF-2503 - 45° (1) Male 45° (2) Male Pipe | BF-2503-F - 45° (Forged) (1) Male 45° (2) Male Pipe | BF-2601 - Tee (1)(2) Male 45° (3) Male Pipe | BF-2601-F - Tee (Forged) (1)(2) Male 45° (3) Male Pipe |
|  |  |  |  |  |  |  |
| BF-2602-F - Tee (Forged) (1)(2) Male 45° (3) Fem. Pipe | BF-2603 - Tee (1)(2)(3) Male 45° Union | BF-2603-F - Tee (Forged) (1)(2)(3) Male 45° Union | BF-2605 - Tee (1)(3) Male 45° (2) Male Pipe | BF-2605-F - Tee (Forged) (1)(3) Male 45° (2) Male Pipe | BF-2613 - Tee (1) Male 45° (2) Male Pipe (3) Fem. Pipe | BF-2650-F - Cross (Forged) (1)(2)(3)(4) Male 45° |
|  |  |  |  | | | |
| BF-2652-F - Cross (Forged) (1)(2)(3) Male 45° (4) Fem. Pipe | BF-6500 - 90° (1) Male 45° (2) 45° Fem. Swivel | BF-6500-F - 90° (Forged) (1) Male 45° (2) 45° Fem. Swivel | BF-MJ-2406 - Str. (1) Fem. 45° SAE (5/8-18) (2) Male 37° (9/16-18) | | | |

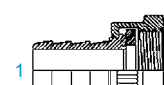
BRASS FITTINGS

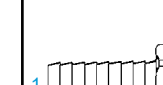
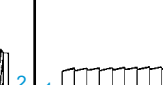
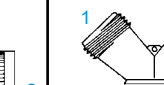



BRASS FUEL LINE

| | | | | | | |
|--|--|---|---|--|--|--|
|  <p>BFL-800 - Str. (1) Hose Bead (2) Male Pipe</p> |  <p>BFL-801 - Str. (1) Hose Bead (2) Male Inv. Flare</p> |  <p>BFL-802 - Str. (1) Hose Bead (2) Male 45° Flare</p> |  <p>BFL-803 - Str. (1) Hose Bead (2) Straight Thread w/Gasket</p> |  <p>BFL-804 - 90° (1) Hose Bead (2) Male Pipe</p> |  <p>BFL-805 - 90° (1) Hose Bead (2) Male Inv. Flare Swivel</p> |  <p>BFL-806 - Tee (1) (2) Hose Barb (3) Male Inv. Flare Swivel</p> |
|--|--|---|---|--|--|--|

BRASS GARDEN HOSE

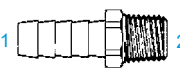
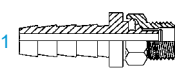
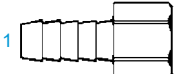
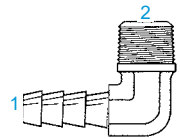
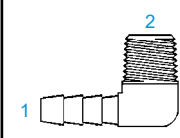
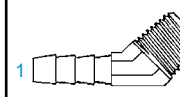
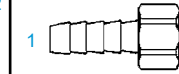
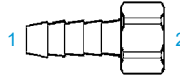
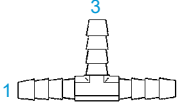
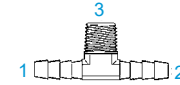
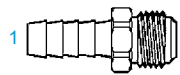
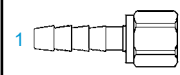
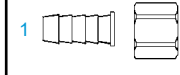
| | | | | | | |
|--|--|---|---|--|--|--|
|  <p>BGH-4106-P - Str. (1) Male Garden Hose Plug</p> |  <p>BGH-4166 - Garden Hose Washer</p> |  <p>BGH-4318-H Garden Hose Hex Nut</p> |  <p>BGH-4318-K Garden Hose Nut-Knurled</p> |  <p>BGH-4501 - Str. (1) Fem. Garden Hose Rigid (2) Fem. Pipe</p> |  <p>BGH-4502 - Str. (1) Fem. Garden Hose Swivel (2) Fem. Pipe</p> |  <p>BGH-4503 - Str. (1) Fem. Garden Hose Rigid (2) Male Pipe</p> |
|  <p>BGH-4503-L - Str. (1) Fem. Garden Hose Rigid (2) Male Pipe</p> |  <p>BGH-4504 - Str. (1) Fem. Garden Hose Swivel (2) Male Pipe</p> |  <p>BGH-4505 - Str. (1) (2) Fem. Garden Hose Rigid</p> |  <p>BGH-4506 - Str. (1) (2) Fem. Garden Hose Swivel</p> |  <p>BGH-4507 - Str. (1) Male Garden Hose (2) Fem. Pipe</p> |  <p>BGH-4508 - Str. (1) Male Garden Hose (2) Male Pipe</p> |  <p>BGH-4509 - Str. (1) (2) Male Garden Hose Union</p> |
|  <p>BGH-4510 - Str. (1) Fem. Garden Hose Rigid (2) Male 45° Flare</p> |  <p>BGH-4511 - Str. (1) Fem. Garden Hose Swivel (2) Male 45° Flare</p> |  <p>BGH-4512 - Str. (1) Male Garden Hose (2) Male 45° Flare</p> |  <p>BGH-4513 - Str. (1) Fem. Garden Hose Cap</p> |  <p>BGH-4514 (1) Garden Hose Cap (2) 8" Chain</p> |  <p>BGH-4578 (1) (2) Garden Hose Mender</p> |  <p>BGH-4585 - Str. (1) Short Hose Barb (2) Male Garden Hose</p> |
|  <p>BGH-4586 - Str. (1) Short Hose Barb (2) Fem. Garden Hose Swivel-Round Nut</p> |  <p>BGH-4588 - Str. (1) Short Hose Barb (2) Fem. Garden Hose Swivel-Hex Nut</p> |  <p>BGH-4590 - Str. (1) Hose Barb (2) Male Garden Hose</p> |  <p>BGH-4591 - Str. (1) Hose Barb (2) Fem. Garden Hose Swivel</p> |  <p>BGH-4593 - Str. (1) Long Hose Barb (2) Male Garden Hose</p> |  <p>BGH-4594 - Str. (1) Long Hose Barb (2) Fem. Garden Hose Swivel</p> |  <p>BGH-4686 - Y (1) (2) Male Garden Hose (3) Fem. Garden Hose Rigid</p> |
|  <p>BGH-4700 - Str. (1) 2.5" Brass Nozzle (2) Fem. Garden Hose Swivel</p> |  <p>BGH-4701 - Str. (1) Crossed Pattern Thinner 3" Brass Nozzle (2) Fem. Garden Hose Swivel</p> |  <p>BGH-4800 - One Way Ball Valve (1) Male Garden Hose (2) Fem. Garden Hose</p> |  <p>B-QC-1690 (1) Socket (2) Fem. Garden Hose</p> |  <p>B-QC-1691 (1) Plug (2) Male Garden Hose</p> | | |

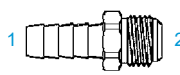
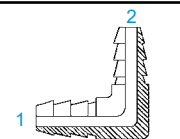
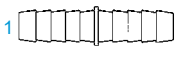
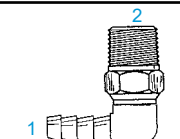
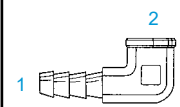
BRASS HOSE BARB



| | | | | | | |
|---|--|---|---|--|--|--|
|  <p>BHB-3102 - Str. (1) Hose Barb (2) Male Pipe</p> |  <p>BHB-3103 - Str. (1) Hose Barb (2) Male Pipe Swivel</p> |  <p>BHB-3104 - Str. (1) Hose Barb (2) Fem. Pipe Rigid</p> |  <p>BHB-3109 - 90° (1) Hose Barb (2) Male Pipe</p> |  <p>BHB-3109-BSK Bar Stock (1) Hose Barb (2) Male Pipe</p> |  <p>BHB-3110 - 45° (1) Hose Barb (2) Male Pipe</p> |  <p>BHB-3124 - Str. (1) Hose Barb (2) Fem. Pipe Swivel Ball Seat</p> |
|  <p>BHB-3126 - Str. (1) Hose Barb (2) Fem. Pipe Swivel Gasket Seat</p> |  <p>BHB-3133 - Tee (1)(2)(3) Hose Barb</p> |  <p>BHB-3134 - Tee (1)(2) Hose Barb (3) Male Pipe</p> |  <p>BHB-3142 - Str. (1) Hose Barb (2) Male 45° Flare</p> |  <p>BHB-3143 - Str. (1) Hose Barb (2) Fem. Dual Seat Swivel (45°/37°)</p> |  <p>BHB-3144 - Str. (1) Hose Barb (2) Fem. 45° Swivel</p> |  <p>BHB-3145 - Str. (1) Hose Barb (2) Fem. 37° Swivel</p> |
|  <p>BHB-3146 - Str. (1) Hose Barb (2) Male 37° Flare</p> |  <p>BHB-3177 - 90° (1)(2) Hose Barb</p> |  <p>BHB-3178 - Str. (1)(2) Hose Barb Splicer</p> |  <p>BHB-3193 - 90° (1) Hose Barb (2) Male Pipe Swivel</p> |  <p>BHB-3194 - 90° (1) Hose Barb (2) Fem. Pipe</p> |  <p>BHB-3290 - Str. (1) Hose Barb (2) Male Inverted Flare Swivel</p> | |

STANDARD INVERTED FLARE TUBE AND THREAD SIZE

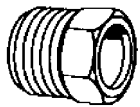
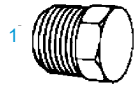
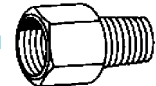
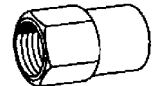

| Dash | 2 | 3 | 4 | 5 | 6 | 7 | 8 | 10 | 12 | 14 | 16 |
|-------------|---------|--------|---------|--------|--------|----------|--------|--------|-----------|-----------|-----------|
| Tube Size | 1/8 | 3/16 | 1/4 | 5/16 | 3/8 | 7/16 | 1/2 | 5/8 | 3/4 | 7/8 | 1 |
| Thread Size | 5/16-28 | 3/8-24 | 7/16-24 | 1/2-20 | 5/8-18 | 11/16-18 | 3/4-18 | 7/8-18 | 1 1/16-16 | 1 3/16-16 | 1 5/16-16 |

BRASS INVERTED FLARE

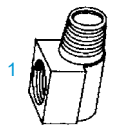
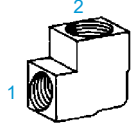
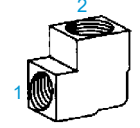
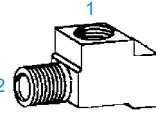
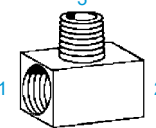
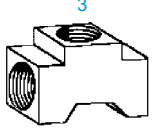
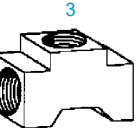
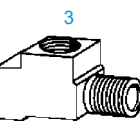
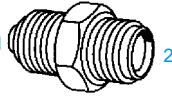

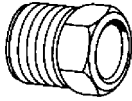
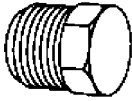
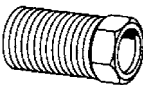
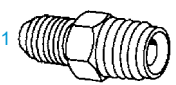
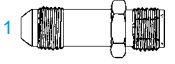

BRASS FITTINGS

| | | | | | | |
|---|--|---|--|---|---|--|
|  <p>BIF-100 - Str. Brass Inv. Flare Nut</p> |  <p>BIF-131 - Str. (1) Brass Inv. Flare Plug</p> |  <p>BIF-202 - Str. (1) Fem. Inv. Flare (2) Male Pipe</p> |  <p>BIF-252 - Str. (1) Fem. Inv. Flare (2) Fem. Pipe</p> |  <p>BIF-302 - Str. (1)(2) Fem. Inv. Flare Union</p> |  <p>BIF-352 - 45° (1) Fem. Inv. Flare (2) Male Pipe</p> |  <p>BIF-402 - 90° (1) Fem. Inv. Flare (2) Male Pipe</p> |
|  <p>BIF-452 - 90° (1) Fem. Inv. Flare (2) Fem. Pipe</p> |  <p>BIF-502 - 90° (1)(2) Fem. Inv. Flare Union</p> |  <p>BIF-552 - Tee (1) Fem. Inv. Flare (2) Male Pipe (3) Fem. Pipe</p> |  <p>BIF-602 - Tee (1)(2) Fem. Inv. Flare (3) Male Pipe</p> |  <p>BIF-652 - Tee (1)(2) Fem. Inv. Flare (3) Fem. Pipe</p> |  <p>BIF-702 - Tee (1)(2)(3) Fem. Inv. Flare Union</p> |  <p>BIF-752 - Tee (1)(3) Fem. Inv. Flare (2) Male Pipe</p> |
|  <p>BIF-2404 - Str. (1) Male 45° Flare (2) Male Inv. Flare</p> | | | | | | |

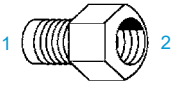
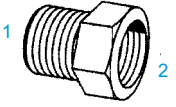
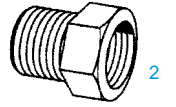
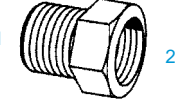
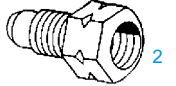
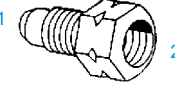
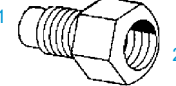
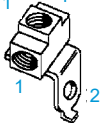
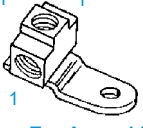
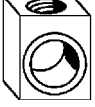
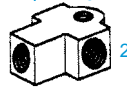

STEEL INVERTED FLARE

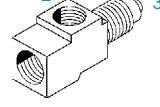
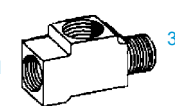
| | | | | | | |
|---|--|---|--|--|---|--|
|  <p>SIF-105 - Str. Steel Inv. Flare Nut</p> |  <p>SIF-131 - Str. Steel Inv. Flare Plug</p> |  <p>SIF-7896 - Str. Steel Inverted Long Flare Nut</p> |  <p>SIF-2404 - Str. - Steel (1) Male 37° Flare (2) Male Inv. Flare</p> |  <p>SIF-2404-LH - Long Hex (1) Male 37° Flare (2) Male Inv. Flare</p> |  <p>SIF - Transmission Oil Coolant Line Adapter</p> | |
|---|--|---|--|--|---|--|

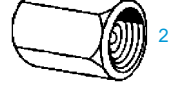



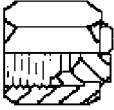

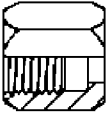
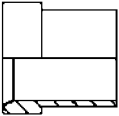
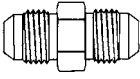
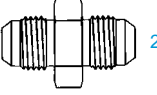
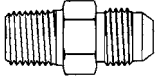
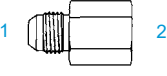
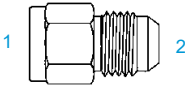
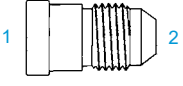
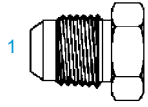
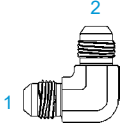
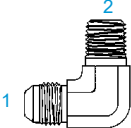
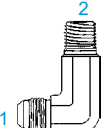
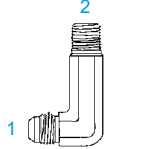
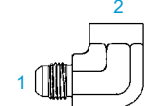
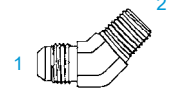
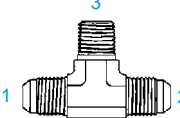
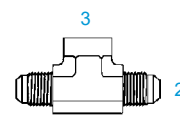
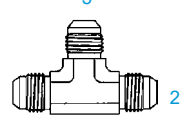
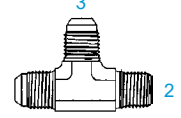
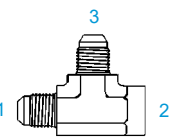
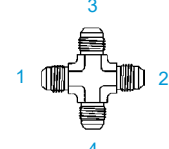
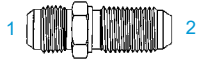
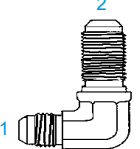
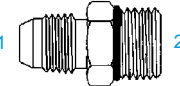
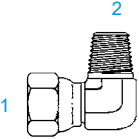
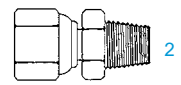
BRASS INVERTED FLARE BRAKE

| | | | | | | |
|--|---|--|---|---|---|--|
|  <p>Dual Master Cylinder Adapter Type 1 (1) Male Inv. Flare (2) Fem. Inv. Flare</p> |  <p>Dual Master Cylinder Adapter Type 2 (1) Male Inv. Flare (2) Fem. Inv. Flare</p> |  <p>Dual Master Cylinder Adapter Type 3 (1) Male Straight Thread (2) Fem. Inv. Flare</p> |  <p>Dual Master Cylinder Adapter Type 4 (1) Male Pipe (2) Fem. Inv. Flare</p> |  <p>Dual Master Cylinder Adapter Type 5 (1) Male Bubble Thread (2) Fem. Inv. Flare</p> |  <p>Metric Adapter Type 1 (1) Male Bubble Thread (2) Tube O.D./ Fem. Thread</p> |  <p>Metric Adapter Type 2 (1) Male Inv. Flare (2) Tube O.D./ Fem. Thread</p> |
|  <p>Strap Tee Assembly Type 1 (1) Fem. Inverted Seat (2) Bolt Hole</p> |  <p>Strap Tee Assembly Type 2 (1) Fem. Inverted Seat (2) Bolt Hole</p> |  <p>Brake Adapter (1) Inverted Seat (2) Bolt Hole</p> |  <p>Rear Axle Tee (1) (2) Inverted Seat (3) Bolt Hole (4) Hose End Port</p> |  <p>Adapter Standard to Metric Bubble Type 1 (1) Male Inch Size Bubble Flare Thread (2) Fem. Inverted Seat</p> |  <p>Adapter Standard to Metric Bubble Type 2 (1) Male Metric Size Bubble Flare Metric Thread (2) Fem. Inverted Seat</p> |  <p>Metric Towed Trailer Brake Tee (1) Fem. Bubble Flare (2) Fem. Inverted Flare (3) Male Bubble Flare</p> |
|  <p>Towed Trailer Brake Tee (1)(2) Fem. Inv. Flare (3) Male Inv. Flare</p> |  <p>Metric Power Steering Adapter (1) Fem. Inv. Bump Tube (2) Male Metric</p> |  <p>BIF-7975 - Metric Union (1)(2) Fem. Bubble Flare</p> | | | | |

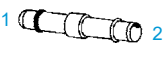
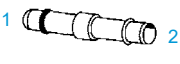
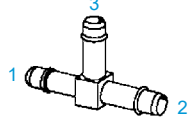
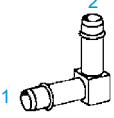
BRASS JIC

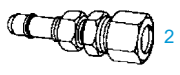
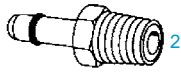
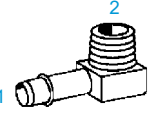
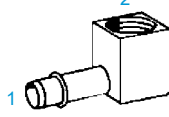
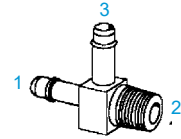
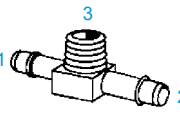

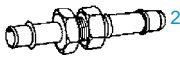
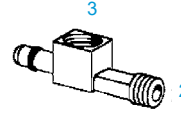
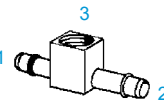
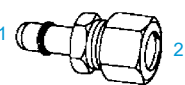
| | | | | | | |
|---|--|---|---|---|---|--|
|  BJ-0304-C Cap Nut |  BJ-0306 Bulkhead Lock Nut |  BJ-0318 37° Nut |  BJ-0319 37° Sleeve |  BJ-2403 - Str. (1)(2) Male 37° Union |  BJ-2403-LH - Str. (1)(2) Male 37° Union Large Hex |  BJ-2404 - Str. (1) Male 37° (2) Male Pipe |
|  BJ-2405 - Str. (1) Male 37° (2) Fem. Pipe |  BJ-2406 - Str. (1) Fem. 37° (2) Male 37° |  BJ-2407 - Str. Reducer Less Nut (1) 37° Fem. (2) Male 37° |  BJ-2408 - Str. (1) Male 37° Plug |  BJ-2500 - 90° (1)(2) Male 37° Union |  BJ-2501 - 90° (1) Male 37° (2) Male Pipe |  BJ-2501-L - 90° Long Male Pipe (1) Male 37° (2) Male Pipe |
|  BJ-2501-LL - 90° Extra Long Male Pipe (1) Male 37° (2) Male Pipe |  BJ-2502 - 90° (1) Male 37° (2) Fem. Pipe |  BJ-2503 - 45° (1) Male 37° (2) Male Pipe |  BJ-2601 - Tee (1)(2) Male 37° (3) Male Pipe |  BJ-2602 - Tee (1)(2) Male 37° (3) Fem. Pipe |  BJ-2603 - Tee (1)(2)(3) Male 37° Union |  BJ-2605 - Tee (1)(3) Male 37° (2) Male Pipe |
|  BJ-2606 - Tee (1)(3) Male 37° (2) Fem. Pipe |  BJ-2650 - Cross (1)(2)(3)(4) Male 37° |  BJ-2700 - Str. (1) Male 37° (2) Bulkhead |  BJ-2701 - 90° (1) Male 37° (2) Bulkhead Tube |  BJ-6400-O - Str. (1) Male 37° (2) Male O-Ring |  BJ-6501 - 90° (1) 37° Fem. Swivel (2) Male Pipe |  BJ-6505 - Str. (1) 37° Fem. Swivel (2) Male Pipe |

BRASS MINI BARB





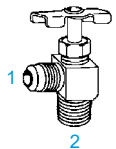
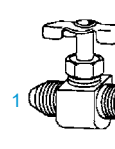
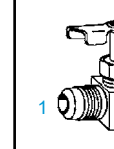

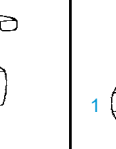
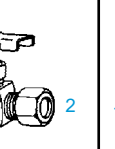
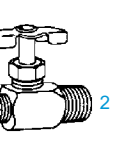
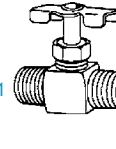
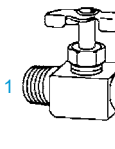
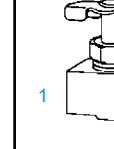
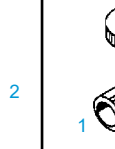
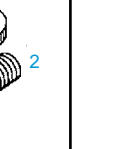
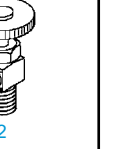
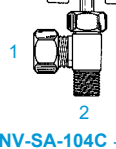
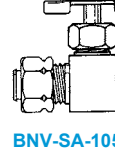
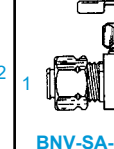



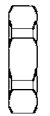
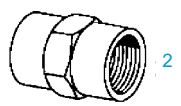
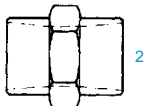
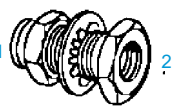
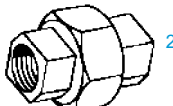
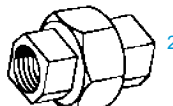
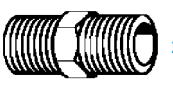
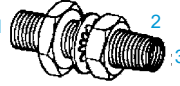
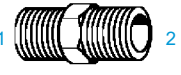
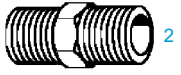
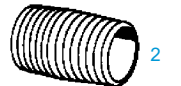
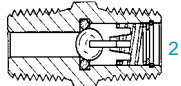
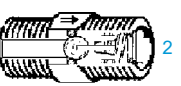
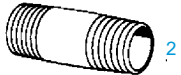
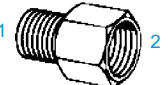

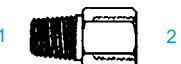



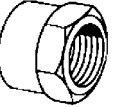

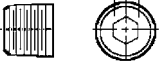
| | | | | | | |
|---|---|---|---|--|--|---|
|  BMB-1062 - Str. (1)(2) Mini Barb Union |  BMB-1062-L - Str. (1)(2) Long Mini Barb Union |  BMB-1064 - Tee (1)(2)(3) Mini Barb Union |  BMB-1065 - 90° (1)(2) Mini Barb Union |  BMB-1066 - Str. (1) Mini Barb (2) Fem. Pipe |  BMB-1067 - Str. (1) Mini Barb (2) Bulkhead Compression |  BMB-1068 - Str. (1) Mini Barb (2) Male Pipe |
|  BMB-1069 - 90° (1) Mini Barb (2) Male Pipe |  BMB-1070 - 90° (1) Mini Barb (2) Fem. Pipe |  BMB-1071 - Tee (1)(3) Mini Barb (2) Male Pipe |  BMB-1072 - Tee (1)(2) Mini Barb (3) Male Pipe |  BMB-1073 - Str. (1) Mini Barb Plug |  BMB-1074 - Str. (1) Mini Barb (2) Bulkhead Mini Barb |  BMB-1075 - Tee (1) Mini Barb (2) Male Pipe (3) Fem. Pipe |
|  BMB-1077 - Tee (1)(2) Mini Barb (3) Fem. Pipe |  BMB-1078 - Str. (1) Mini Barb (2) Compression |  BMB-1079 - Str. (1) Mini Barb (2) Solder Connection | | | | |

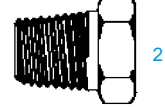
BRASS FITTINGS

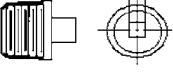
BRASS NEEDLE VALVE

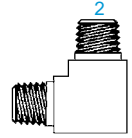
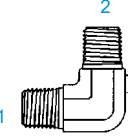
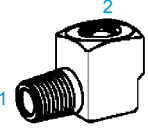
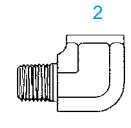
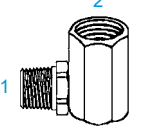
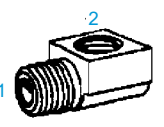
| | | | | | | |
|---|---|--|--|--|---|--|
|  <p>BNV-101F - 90° (1) Male 45° Flare (2) Male Pipe</p> |  <p>BNV-102F - Str. (1)(2) Male 45° Flare</p> |  <p>BNV-103F - Str. (1) Male 45° Flare (2) Male Pipe</p> |  <p>BNV-104C - 90° (1) Compression (2) Male Pipe</p> |  <p>BNV-105C - Str. (1)(2) Compression</p> |  <p>BNV-106C - Str. (1) Compression (2) Male Pipe</p> |  <p>BNV-106IF - Str. (1) Inv. Flare w/ Nut (2) Male Pipe</p> |
|  <p>BNV-107P - Str. (1)(2) Male Pipe</p> |  <p>BNV-108P - Str. (1) Male Pipe (2) Fem. Pipe</p> |  <p>BNV-109P - Str. (1)(2) Fem. Pipe</p> |  <p>BNV-311P - Str. (1) Poly Flow (2) Male Pipe</p> |  <p>BNV-312P - 90° (1) Poly Flow (2) Male Pipe</p> |  <p>BNV-K-104C - Steel Saddle Valve Kit (1) Compression</p> | |
|  <p>BNV-SA-104C - 90° (1) Compression (2) Male Pipe</p> |  <p>BNV-SA-105C - Str. (1)(2) Compression</p> |  <p>BNV-SA-106C - Str. (1) Compression (2) Male Pipe</p> | | | | |

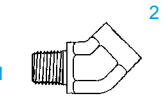
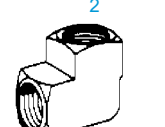
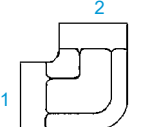
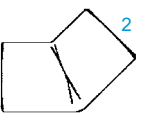
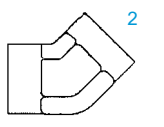
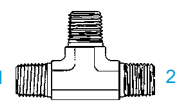
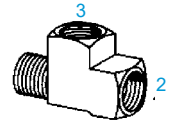
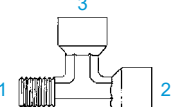
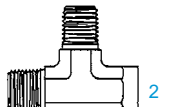
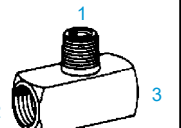
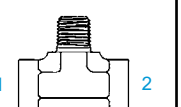
BRASS PIPE

| | | | | | | |
|---|--|---|---|--|--|--|
|  <p>BP-0306 - Bulkhead Lock Nut</p> |  <p>BP-5000 - Str. (1)(2) Fem. Pipe</p> |  <p>BP-5000-CV - Str. Check Valve (1)(2) Fem. Pipe</p> |  <p>BP-5000-BH - Str. (1)(2) Fem. Pipe Bulkhead</p> |  <p>BP-5000-U - Str. (Union) (1)(2) Fem. Pipe</p> |  <p>BP-5000-F-U - Str. (Forged Union) (1)(2) Fem. Pipe</p> |  <p>BP-5404 - Str. (1)(2) Male Pipe</p> |
|  <p>BP-5404-BH - Str. (1)(2) Male Pipe (3) Fem. Pipe</p> |  <p>BP-5404-BV40 - Str. (1)(2) Male Pipe w/ 40 Micron Filter</p> |  <p>BP-5404-BV90 - Str. (1)(2) Male Pipe w/ 90 Micron Filter</p> |  <p>BP-5404-CL - Str. (1)(2) Close Male Pipe</p> |  <p>BP-5404-CV-M - Str. Check Valve w/ Metal to Metal Seat (1)(2) Male Pipe</p> |  <p>BP-5404-CV-O - Str. Check Valve w/ O-Ring (1)(2) Male Pipe</p> |  <p>BP-5404-N - Str. Nipple (1)(2) Male Pipe</p> |
|  <p>BP-5405 - Str. (1) Male Pipe (2) Fem. Pipe</p> |  <p>BP-5405-BH - Str. (1) Male Pipe (2) Fem. Pipe Bulkhead</p> |  <p>BP-5405-R - Str. Restrictor (1) Male Pipe (2) Fem. Pipe</p> |  <p>BP-5405-S - Str. Swivel Adapters (1) Male Pipe (2) Fem. Pipe Swivel</p> |  <p>BP-5406 - Str. Bushing (1) Male Pipe (2) Fem. Pipe</p> |  <p>BP-5406-BM40 Conical Breather Muffler (1) 40 Micron Filter (2) Male Pipe</p> |  <p>BP-5406-BV40 - Str. Breather Vent (1) 40 Micron Filter (2) Male Pipe</p> |
|  <p>BP-5406-C - Pipe Cap</p> |  <p>BP-5406-FB - (Face Bushing) (1) Male Pipe (2) Fem. Pipe</p> |  <p>BP-5406-FS-HHP 7/8 Taper Hex Socket Plug</p> |  <p>BP-5406-HHP Hex Socket Plug</p> |  <p>BP-5406-P-DRL Drilled Plug (1) Pipe Plug</p> |  <p>BP-5406-P-SLD Solid Plug (1) Pipe Plug</p> |  <p>BP-5406-SHP Square Head Plug (1) Pipe Plug</p> |
|  <p>BP-5406-SPP - Slot Head Pipe Plug (1) Pipe Plug</p> |  <p>BP-5406-SSP Square Socket Plug (1) Pipe Plug</p> |  <p>BP-5500 - 90° (1)(2) Male Pipe</p> |  <p>BP-5500-F - 90° (Forged) (1)(2) Male Pipe</p> |  <p>BP-5502 - 90° (1) Male Pipe (2) Fem. Pipe</p> |  <p>BP-5502-F - 90° (Forged) (1) Male Pipe (2) Fem. Pipe</p> |  <p>BP-5502-S - 90° Swivel (1) Male Pipe (2) Fem. Pipe</p> |
|  <p>BP-5502-SB - 90° Short Body (1) Male Pipe (2) Fem. Pipe</p> |  <p>BP-5503 - 45° (1) Male Pipe (2) Fem. Pipe</p> |  <p>BP-5503-F - 45° (Forged) (1) Male Pipe (2) Fem. Pipe</p> |  <p>BP-5504 - 90° (1)(2) Fem. Pipe</p> |  <p>BP-5504-F - 90° (Forged) (1) (2) Fem. Pipe</p> |  <p>BP-5505 - 45° (1)(2) Fem. Pipe</p> |  <p>BP-5505-F - 45° (Forged) (1)(2) Fem. Pipe</p> |
|  <p>BP-5600-F - Tee (Forged) (1)(2)(3) Male Pipe</p> |  <p>BP-5602 - Tee (1) Male Pipe (2)(3) Fem. Pipe</p> |  <p>BP-5602-F - Tee (Forged) (1) Male Pipe (2)(3) Fem. Pipe</p> |  <p>BP-5603-F - Tee (Forged) (1)(3) Male Pipe (2) Fem. Pipe</p> |  <p>BP-5604 - Tee (1) Male Pipe (2)(3) Fem. Pipe</p> |  <p>BP-5604-F - Tee (Forged) (1)(2) Fem. Pipe (3) Male Pipe</p> |  <p>BP-5605 - Tee (1)(2)(3) Fem. Pipe</p> |

BRASS FITTINGS

BRASS PIPE

| | | | | | | |
|--|--|---|---|---|---|--|
| <p>BP-5605-F - Tee (Forged) (1)(2)(3) Fem. Pipe</p> | <p>BP-5652 - Cross (1)(2)(3)(4) Fem. Pipe</p> | <p>BP-5652-F - Cross (Forged) (1)(2)(3)(4) Fem. Pipe</p> | <p>BP-BJO-8050-BO - 90° Body Only (1) Fem. Pipe (2) Banjo Body</p> | <p>BP-BS-5172 - Str. (1) Male Pipe (2) Male NPSM Ball Seat</p> | <p>BP-BS-5174 - Str. (1) Male NPSM Ball Seat (2) Fem. NPTF Taper</p> | <p>BP-BS-5176 - Str. (1)(2) Male NPSM Ball Seat</p> |
|--|--|---|---|---|---|--|

BRASS PUSH CONNECT

| | | | | | | |
|--|---|--|---|--|---|--|
| <p>BPC-2161 - Cartridge (1) Tube</p> | <p>BPC-2323 - Str. (1)(2) Stem Union</p> | <p>BPC-2403 - Str. (1)(2) Tube Union</p> | <p>BPC-2404 - Str. (1) Tube (2) Male Pipe</p> | <p>BPC-2405 - Str. (1) Tube (2) Fem. Pipe</p> | <p>BPC-2406 - Str. Reducer/Expander (1) Stem (2) Tube</p> | <p>BPC-2408 - Str. (1) Tube Plug</p> |
| <p>BPC-2500 - 90° (1)(2) Tube Union</p> | <p>BPC-2501 - 90° (1) Tube (2) Male Pipe</p> | <p>BPC-2501-S - 90° (1) Tube (2) Male Pipe Swivel</p> | <p>BPC-2502 - 90° (1) Tube (2) Fem. Pipe</p> | <p>BPC-2502-S - 90° (1) Tube (2) Fem. Pipe Swivel</p> | <p>BPC-2601 - Tee (1)(2) Tube (3) Male Pipe</p> | <p>BPC-2601-S - Tee (1)(2) Tube (3) Male Pipe Swivel</p> |
| <p>BPC-2602 - Tee (1)(2) Tube (3) Fem. Pipe</p> | <p>BPC-2603 - Tee (1)(2)(3) Tube Union</p> | <p>BPC-2605 - Tee (1)(3) Tube (2) Male Pipe</p> | <p>BPC-2605-S - Tee (1)(3) Tube (2) Male Pipe Swivel</p> | <p>BPC-2650 - Cross (1)(2)(3)(4) Male Tube</p> | <p>BPC-2700-LN - Str. (1) Tube (2) Bulkhead Tube</p> | <p>BPC-2705-LN - Str. (1) Bulkhead Tube (2) Fem. Pipe</p> |
| <p>BPC-3102 - Str. (1) Stem (2) Male Pipe</p> | <p>BPC-4107 - "Y" (1)(2)(3) Tube</p> | <p>BPC-4108 - "Y" (1)(2) Tube (3) Male Pipe</p> | <p>BPC-4109 - "Y" (1)(2) Tube (3) Stem</p> | <p>BPC-4110 - Banjo (1) Tube Bolt (2) Banjo</p> | <p>BPC-SO-2404 - Str. (1) Tube (2) Male Pipe w/ Shut Off Valve</p> | |



BRASS POLY FITTINGS

| | | | | | | |
|------------------------------------|-------------------------------------|--------------------------------------|---|---|--|--|
| <p>BPF-N-0304-C Cap</p> | <p>BPF-0306 Bulkhead Nut</p> | <p>BPF-0318 Brass Nut</p> | <p>BPF-0319-B Brass Sleeve</p> | <p>BPF-0319-P Plastic Sleeve</p> | <p>BPF-0320-B Brass Nut w/ Brass Sleeve Assm.</p> | <p>BPF-0320-P Brass Nut w/ Plastic Sleeve Assm.</p> |
|------------------------------------|-------------------------------------|--------------------------------------|---|---|--|--|

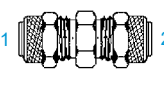
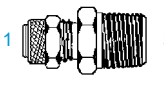
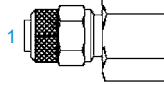
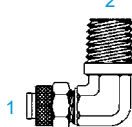
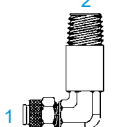
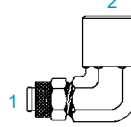
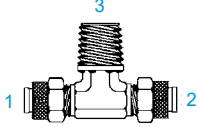
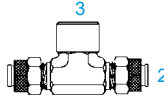
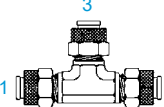
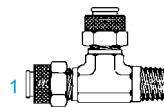
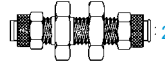
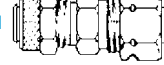
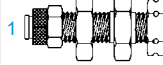
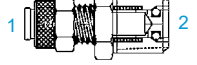

BRASS POLY FITTINGS

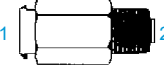
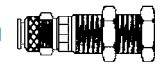
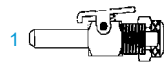
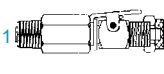
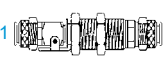
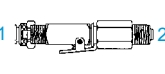
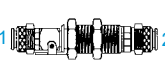
| | | | | | | |
|---|---|---|---|---|--|--|
|  <p>BPF-2403 - Str. (1)(2) Poly Flow Union</p> |  <p>BPF-2404 - Str. (1) Poly Flow (2) Male Pipe</p> |  <p>BPF-2405 - Str. (1) Poly Flow (2) Fem. Pipe</p> |  <p>BPF-2501 - 90° (1) Poly Flow (2) Male Pipe</p> |  <p>BPF-2501-L - 90° (1) Poly Flow (2) Male Pipe Long</p> |  <p>BPF-2502 - 90° (1) Poly Flow (2) Fem. Pipe</p> |  <p>BPF-2601 - Tee (1)(2) Poly Flow (3) Male Pipe</p> |
|  <p>BPF-2602 - Tee (1)(2) Poly Flow (3) Fem. Pipe</p> |  <p>BPF-2603 - Tee (1)(2)(3) Poly Flow Union</p> |  <p>BPF-2605 - Tee (1)(3) Poly Flow (2) Male Pipe</p> |  <p>BPF-2700-LN - Str. (1) Poly Flow (2) Bulkhead Poly Flow</p> |  <p>BPF-BC-2403 - Str. (1) Poly Flow (2) Brass Compression</p> |  <p>BPF-BC-2700-LN - Str. (1) Poly Flow (2) Bulkhead Compression</p> |  <p>BPF-SO-2404 - Str. (1) Poly Flow (2) Male Pipe w/ Shut Off Valve</p> |





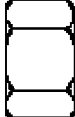
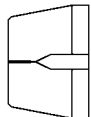
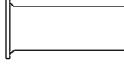
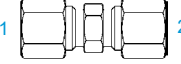

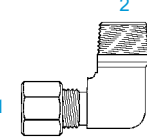



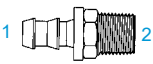

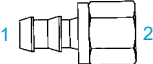
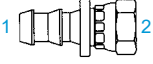
BRASS POLY FITTINGS KWIK CONNECT

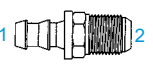
| | | | | | | |
|--|---|--|---|--|---|---|
|  <p>BPF-KC-BO-2404 (1) Insert End (2) Male Pipe</p> |  <p>BPF-KC-BO-2700-LN (1) Bulkhead Poly Flow (2) Insert End</p> |  <p>BPF-KCS-BO-2000 Insert Single End Shut Off (1) Poly Flow (2) Insert - Non Valved</p> |  <p>BPF-KCS-A-2404 Single Shut Off (1) Poly Flow Kwik Connect (2) Male Pipe</p> |  <p>BPF-KCS-A-2700-LN Single Shut Off (1) Poly Flow Kwik Connect (2) Bulkhead Poly Flow</p> |  <p>BPF-KCD-A-2404 Double Shut Off (1) Poly Flow Kwik Connect (2) Male Pipe</p> |  <p>BPF-KCD-A-2700-LN Double Shut Off (1) Poly Flow Kwik Connect (2) Bulkhead Poly Flow</p> |
|  <p>BPF-KCD-BO-2000 Insert Double End Shut Off (1) Poly Flow (2) Insert - Valved</p> | | | | | | |



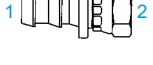

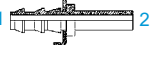

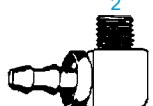

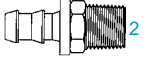
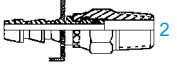

BRASS PRECISION GRIP TRANSMISSION FITTINGS

| | | | | | |
|--|---|---|---|---|---|
|  <p>BPG-0318 - Nut</p> |  <p>BPG-0319 - Sleeve</p> |  <p>BPG-0363 Brass Insert</p> |  <p>BPG-2403 - Str. (1)(2) Precision Grip Union</p> |  <p>BPG-2404 - Str. (1) Precision Grip (2) Male Pipe</p> |  <p>BPG-2501 - 90° (1) Precision Grip (2) Male Pipe</p> |
|--|---|---|---|---|---|

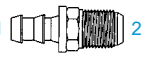
BRASS PUSH ON

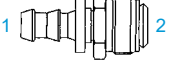
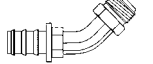
| | | | | | | |
|--|---|---|--|---|--|---|
|  <p>BPO-2272 - Str. (1) Push On (2) Male Pipe</p> |  <p>BPO-2273 - Str. (1) Push On (2) Male Pipe Swivel</p> |  <p>BPO-2274 - Str. (1) Push On (2) Fem. Pipe Rigid</p> |  <p>BPO-2278 - Str. (1) Push On (2) Fem. Pipe Swivel Ball Seat</p> |  <p>BPO-2280 - Str. (1) Push On (2) Fem. Pipe Swivel Gasket Seat</p> |  <p>BPO-2282 - Str. (1) Push On (2) Male 45° Flare</p> |  <p>BPO-2284 - Str. (1) Hose Barb (2) Fem. 45° Swivel</p> |
|  <p>BPO-2286 - Str. (1) Push On (2) Male 37° Flare</p> |  <p>BPO-2287 - Str. (1) Push On (2) Fem. Dual Seat Swivel (45° / 37°)</p> |  <p>BPO-2288 - Str. (1) Push On (2) Fem. 37° Swivel</p> |  <p>BPO-2290 - Str. (1) Push On (2) Male Inv. Flare Swivel</p> |  <p>BPO-2292 - Str. (1) Push On (2) Fem. Inv. Flare Rigid</p> |  <p>BPO-2294 - Str. (1) Push On (2) Tube Shank</p> |  <p>BPO-2296 - Str. (1)(2) Hose Splicer</p> |
|  <p>BPO-2299 - 90° (1) Push On (2) Male Pipe</p> | | | | | | |

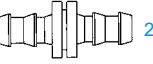

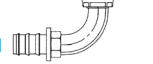
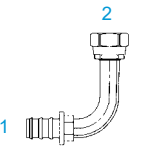

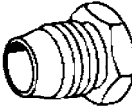
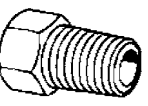
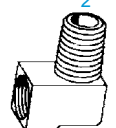

STEEL PUSH ON

| | | | | | | |
|---|--|--|--|--|--|---|
|  <p>SPO-2272 - Str. (1) Push On (2) Male Pipe</p> |  <p>SPO-2273 - Str. (1) Push On (2) Male Pipe Swivel</p> |  <p>SPO-2274 - Str. (1) Push On (2) Fem. Pipe Rigid</p> |  <p>SPO-2280 - Str. (1) Push On (2) Fem. Pipe Swivel Gasket Seat</p> |  <p>SPO-2284 - Str. (1) Push On (2) Fem. 45° Swivel</p> |  <p>SPO-2286 - Str. (1) Push On (2) Male 37° Flare</p> |  <p>SPO-2287 - Str. (1) Push On (2) Fem. Dual Seat Swivel (45° / 37°)</p> |
|  <p>SPO-2288 - Str. (1) Push On (2) Fem. 37° Swivel</p> |  <p>SPO-2290 - Str. (1) Push On (2) Male Inv. Flare Swivel</p> |  <p>SPO-2291 - Str. (1) Push On (2) Male Inv. Flare Swivel</p> |  <p>SPO-2293 - Str. (1) Push Onb (2) Male Inv. Flare Swivel</p> |  <p>SPO-2296 - Str. (1)(2) Hose Splicer</p> |  <p>SPO-2305 - 45° (1) Push On (2) Fem. 37° Swivel</p> |  <p>SPO-2306 - 90° (1) Push On (2) Fem. 37° Swivel</p> |
|  <p>SPO-2306-L - 90° (1) Push On (2) Fem. 37° Swivel - long</p> | | | | | | |

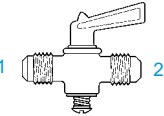
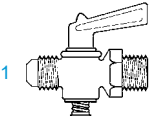
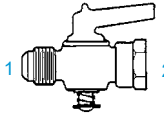
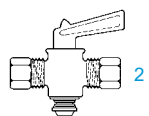
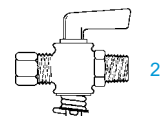
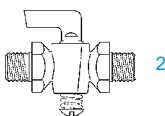
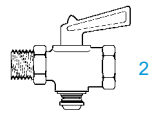
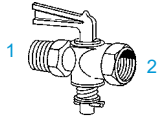
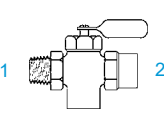
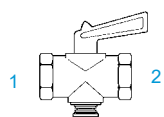

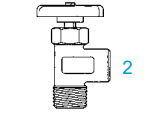

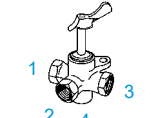
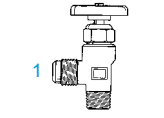
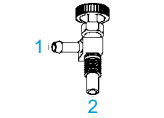
BRASS THREADED SLEEVE

| | | | | | | |
|---|--|---|--|--|--|--|
|  <p>BTS-6100 - Str. (1) Brass Threaded Sleeve Nut</p> |  <p>BTS-6200 - Str. (1) Fem. Threaded Sleeve (2) Male Pipe</p> |  <p>BTS-6400 - 90° (1) Fem. Threaded Sleeve (2) Male Pipe</p> | | | | |
|---|--|---|--|--|--|--|

BRASS VALVE

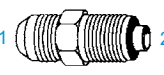
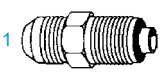

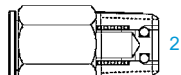

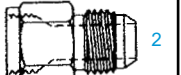

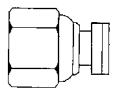
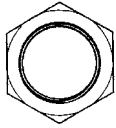
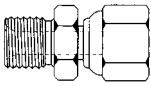
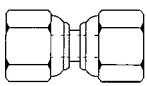
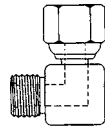
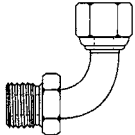
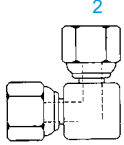
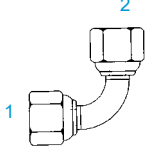
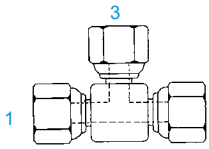
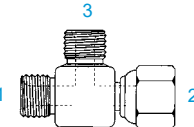
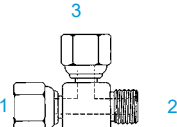

| | | | | | | |
|---|--|---|--|--|---|--|
|  <p>BV-203F - Str. (1)(2) Male 45° Flare</p> |  <p>BV-204F - Str. (1) Male 45° Flare (2) Male Pipe</p> |  <p>BV-209F - Str. (1) Male 45° Flare (2) Fem. Pipe</p> |  <p>BV-303C - Str. (1)(2) Compression</p> |  <p>BV-304C - Str. (1) Compression (2) Male Pipe</p> |  <p>BV-401P - Str. (1)(2) Male Pipe</p> |  <p>BV-402P - Str. (1) Male Pipe (2) Fem. Pipe</p> |
|  <p>BV-402P-HP - Str. (125 PSI) (1) Male Pipe (2) Fem. Pipe</p> |  <p>BV-402P-UL - Str. (Marine) (1) Male Pipe (2) Fem. Pipe</p> |  <p>BV-403P - Str. (1)(2) Fem. Pipe</p> |  <p>BV-404P - 90° (150 PSI) (1) Hose (2) Male Pipe</p> |  <p>BV-405P - 90° (150 PSI) (1) Male Pipe (2) Fem. Pipe</p> |  <p>BV-406P - 3 Way (1)(2)(3) Fem. Pipe</p> |  <p>BV-407P - 4 Way (1)(2)(3)(4) Fem. Pipe</p> |
|  <p>BV-407P-L - 4 Way w/ Long Stem (1)(2)(3)(4) Fem. Pipe</p> |  <p>BV-409F - 90° (1) Male 45° Flare (2) Male Pipe</p> |  <p>BV-6600 - Gasoline Shut-Off w/ Screen Filter (1) Hose (2) Male Pipe</p> |  <p>SV-404P - 90° (150 PSI) (1) Hose (2) Male Pipe</p> |  <p>SV-445P (1) Hose (2) Male Pipe</p> | | |

BRASS MISCELLANEOUS ADAPTERS

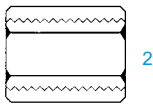
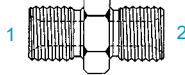
| | | | | | | |
|---|---|---|---|---|--|--|
|  <p>BBT-2404 - Str. (Brass) (1) Male 37° Flare (2) Male Bump Tube (SAE)</p> |  <p>SBT-2404 - Str. (Steel) (1) Male 37° Flare (2) Male Bump Tube (SAE)</p> |  <p>B-6410-BV (1) Male SAE w/ 40 Micron Bronze Filter</p> |  <p>BPC-SO-2404 - Str. (1) Tube (2) Male Pipe w/ Shut Off Valve</p> |  <p>BF-MJ-2406 - Str. (1) Fem. 45° SAE (5/8-18) (2) Male 37° (9/16-18)</p> |  <p>SF-FJ-2406 - Str. (1) Fem. 37° (9/16-18) (2) Male 45° SAE (5/8-18)</p> | |
|---|---|---|---|---|--|--|

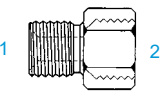
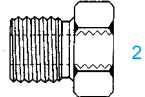
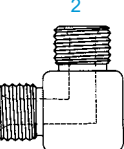
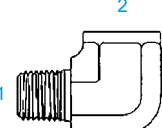
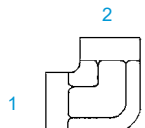
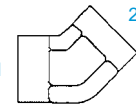
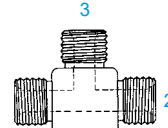
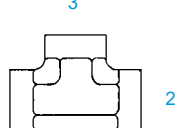
INTERNATIONAL AND CONVERSION ADAPTERS

BRITISH PARALLEL PIPE

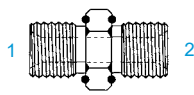
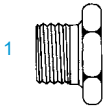
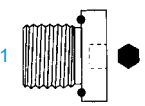
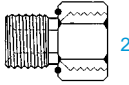
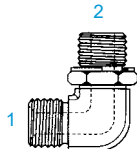
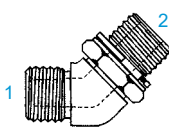
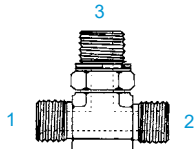
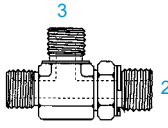
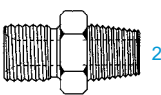
| | | | | | |
|---|--|--|---|---|---|
|  <p>BPP-0304-C Fem. BPP Swivel Cap</p> |  <p>BPP-0306 Bulkhead Lock Nut</p> |  <p>BPP-1404 - Str. (1) Male BPP (2) Fem. BPP Swivel</p> |  <p>BPP-1406 - Str. (1)(2) Fem. BPP Swivel</p> |  <p>BPP-1501 - 90° (1) Male BPP (2) Fem. BPP Swivel</p> |  <p>BPP-1501-L - 90° (1) Male BPP (2) Fem. BPP Swivel - Long</p> |
|  <p>BPP-1506 - 90° (1)(2) Fem. BPP Swivel</p> |  <p>BPP-1506-L - 90° (1)(2) Fem. BPP Swivel Long</p> |  <p>BPP-1603 - Tee (1)(2)(3) Fem. BPP Swivel</p> |  <p>BPP-1662 - Tee (1)(3) Male BPP (2) Fem. BPP Swivel</p> |  <p>BPP-1663 - Tee (1) Male BPP (2)(3) Fem. BPP Swivel</p> |  <p>BPP - 4000 O-Ring (use w/ retainer washer)</p> |
|  <p>BPP-4000 - EO Peflex Seal</p> |  <p>BPP-5000 - Str. (1)(2) Fem. BPP</p> |  <p>BPP-5404 - Str. (1)(2) Male BPP</p> |  <p>BPP-5404-BH-LN - Str. (1) Male BPP (2) Male BPP Bullhead w/ locknut</p> |  <p>BPP-5405 - Str. (1) Male BPP (2) Fem. BPP</p> |  <p>BPP-5406 - Str. Bushing (1) Male BPP (2) Fem. BPP</p> |
|  <p>BPP-5500 - 90° (1)(2) Male BPP</p> |  <p>BPP-5502 - 90° (1) Male BPP (2) Fem. BPP</p> |  <p>BPP-5504 - 90° (1)(2) Fem. BPP</p> |  <p>BPP-5505 - 45° (1)(2) Fem. BPP</p> |  <p>BPP-5600 - Tee (1)(2)(3) Male BPP</p> |  <p>BPP-5605 - Tee (1)(2)(3) Fem. BPP</p> |
|  <p>BPP-6000 BPP Retainer Washer</p> |  <p>BPP-6000 - C Copper Crush Washer</p> |  <p>BPP-6001 BPP Bonded Seal</p> |  <p>BPP-6403-EO - Str. (1) Male BPP w/ Peflex Seal (2) Male BPP w/ Peflex Seal</p> |  <p>BPP-6408 (1) Male BPP Plug</p> |  <p>BPP-6408-HHP-EO (1) Male BPP Hollow Hex Plug w/ Peflex Seal</p> |
|  <p>BPP-6410-EO - Str. (1) Male BPP w/ Peflex Seal (2) Fem. BPP</p> |  <p>BPP-7801-NW0 - 90° (1) Male BPP (2) Male BPP Adj. O-Ring</p> |  <p>BPP-7802-NW0 - 45° (1) Male BPP (2) Male BPP Adj. O-Ring</p> |  <p>BPP-7803-NW0 - Tee (1)(2) Male BPP (3) Male BPP Adj. O-Ring</p> |  <p>BPP-7804-NW0 - Tee (1)(3) Male BPP (2) Male BPP Adj. O-Ring</p> |  <p>BPP-BST-5404 - Str. (1) Male BPP (2) Male BSPT</p> |

* Some BPP may not be Chamfer

BRITISH PARALLEL PIPE

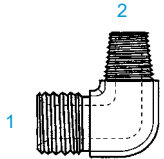
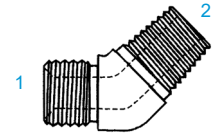
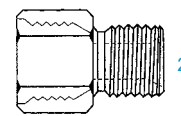
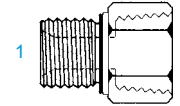
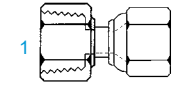
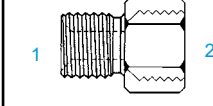
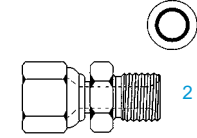
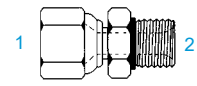
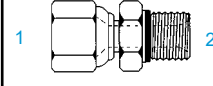
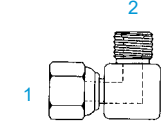
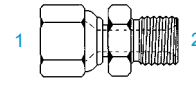
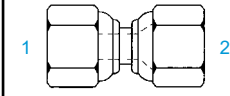
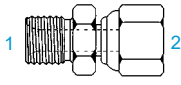
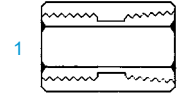
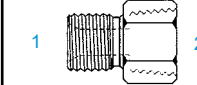
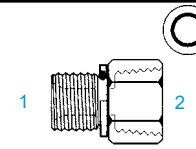
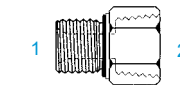
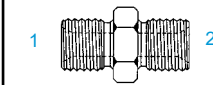
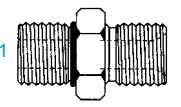
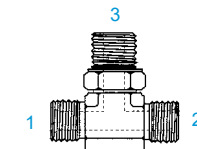
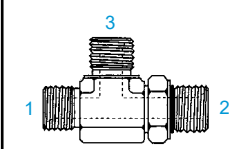
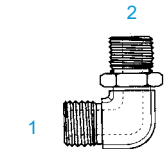
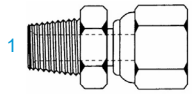
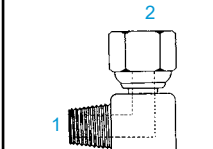
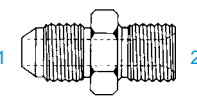
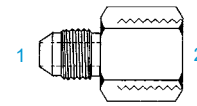
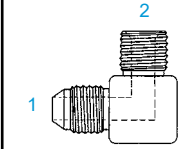
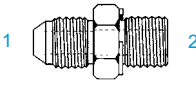
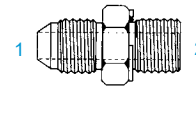
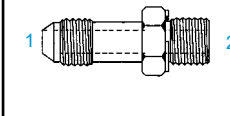
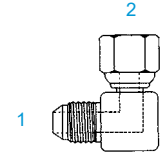
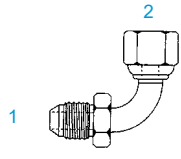
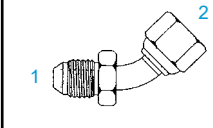
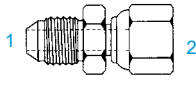
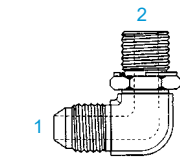
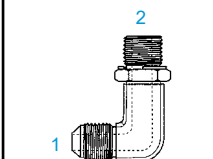

| | | | | | |
|---|--|--|---|--|---|
|  <p>BPP-BST-5500 - 90° (1) Male BPP (2) Male BSPT</p> |  <p>BPP-BST-5501 - 45° (1) Male BPP (2) Male BSPT</p> |  <p>BPP-FB-6410 - Str. (1) Fem. O-Ring (2) Male BPP</p> |  <p>BPP-FB-6410-WO - Str. (1) Male BPP w/ Washer O-Ring (2) Fem. O-Ring</p> |  <p>BPP-FBST-1405 - Str. (1) Fem. BSPT (2) Fem. BPP Swivel</p> |  <p>BPP-FBST-5405 - Str. (1) Male BPP (2) Fem. BSPT</p> |
|  <p>BPP-FJX-6402-DS - Str. (1) 37° Fem. Swivel (2) Male BPP w/ Bonded Seal</p> |  <p>BPP-FJX-6402-EO - Str. (1) 37° Fem. Swivel (2) Male BPP w/ Peflex Seal</p> |  <p>BPP-FJX-6402-WO - Str. (1) 37° Fem. Swivel (2) Male BPP w/ Washer O-Ring</p> |  <p>BPP-FJX-6501 - 90° (1) 37° Fem. Swivel (2) Male BPP</p> |  <p>BPP-FJX-6505 - Str. (1) 37° Fem. Swivel (2) Male BPP</p> |  <p>BPP-FJX-6565 - Str. (1) 37° Fem. Swivel (2) Fem. BPP Swivel</p> |
|  <p>BPP-FOFS-6510 - Str. (1) Male BPP (2) Fem. O-Ring Face Seal Swivel (SAE)</p> |  <p>BPP-FP-5000 - Str. (1) Fem. BPP (2) Fem. Pipe</p> |  <p>BPP-FP-5405 - Str. (1) Male BPP (2) Fem. Pipe</p> |  <p>BPP-FP-6405-DS - Str. (1) Male BPP w/ Bonded Seal (2) Fem. Pipe</p> |  <p>BPP-FP-6405-WO - Str. (1) Male BPP w/ Washer O-Ring (2) Fem. Pipe</p> |  <p>BPP-M-5404 - Str. (1) Male BPP (2) Male Metric</p> |
|  <p>BPP-MB-6401-O - Str. (1) Male O-Ring (SAE) (2) Male BPP</p> |  <p>BPP-MB-6803-NWO - Tee (1)(2) Male BPP (3) Male Adj. O-Ring (SAE)</p> |  <p>BPP-MB-6804-NWO - Tee (1) (3) Male BPP (2) Male Adj. O-Ring (SAE)</p> |  <p>BPP-MB-6806-NWO - 90° (1) Male BPP (2) Male Adj. O-Ring (SAE)</p> |  <p>BPP-MBST-1404 - Str. (1) Male BSPT (2) Fem. BPP Swivel</p> |  <p>BPP-MBST-1501 - 90° (1) Male BSPT (2) Fem. BPP Swivel</p> |
|  <p>BPP-MJ-2404 - Str. (1) Male 37° (2) Male BPP 30° Seat</p> |  <p>BPP-MJ-2405 - Str. (1) Male 37° (2) Fem. BPP (Rigid)</p> |  <p>BPP-MJ-2501 - 90° (1) Male 37° (2) Male BPP 30° Seat</p> |  <p>BPP-MJ-6400-DS - Str. (1) Male 37° (2) Male BPP w/ Bonded Seal</p> |  <p>BPP-MJ-6400-WO - Str. (1) Male 37° (2) Male BPP w/ Washer O-Ring</p> |  <p>BPP-MJ-6400-L-WO - Str. (1) Male 37° Long (2) Male BPP - w/ Washer & O-Ring</p> |
|  <p>BPP-MJ-6500 - 90° (1) Male 37° (2) Fem. BPP Swivel</p> |  <p>BPP-MJ-6500-L - 90° (1) Male 37° (2) Fem. BPP Swivel - Long</p> |  <p>BPP-MJ-6502-L - 45° (1) Male 37° (2) Fem. BPP Swivel - Long</p> |  <p>BPP-MJ-6510 - Str. (1) Male 37° (2) Fem. BPP Swivel</p> |  <p>BPP-MJ-6801-NWO - 90° (1) Male 37° (2) Male BPP Adj. O-Ring w/ Retainer Washer</p> |  <p>BPP-MJ-6801-L-NWO - 90° (1) Male 37° (2) Male BPP Adj. O-Ring w/ Retainer Washer - Long</p> |

INTERNATIONAL

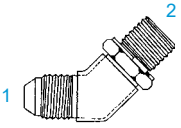
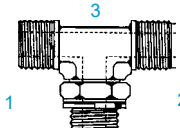
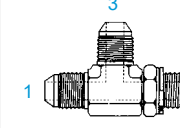
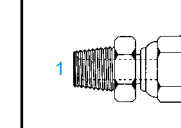
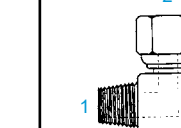
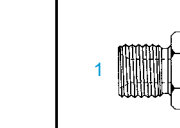
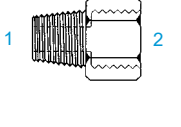
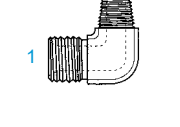
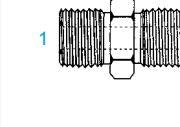
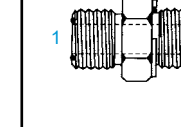
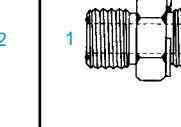
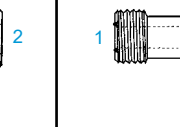
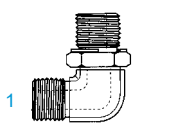
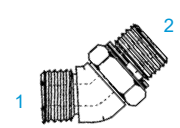
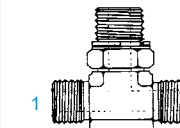
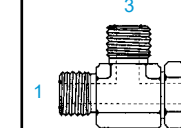
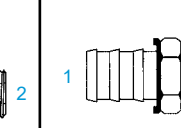
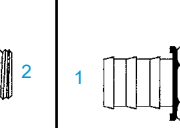
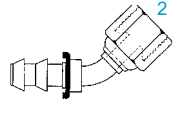
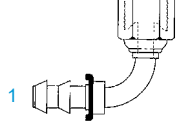
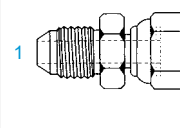
BRITISH PARALLEL PIPE

| | | | | | |
|---|--|--|--|--|--|
|  <p>BPP-MJ-6802-NWO - 45° (1) Male 37° (2) Male BPP Adj. O-Ring w/ Retainer Washer</p> |  <p>BPP-MJ-6803-NWO - Tee (1)(2) Male 37° (3) Male BPP Adj. O-Ring w/ Retainer Washer</p> |  <p>BPP-MJ-6804-NWO - Tee (1)(3) Male 37° (2) Male BPP Adj. O-Ring w/ Retainer Washer</p> |  <p>BPP-MP-1404 - Str. (1) Male NPT Pipe (2) Fem. BPP Swivel</p> |  <p>BPP-MP-1501 - 90° (1) Male NPT Pipe (2) Fem. BPP Swivel</p> |  <p>BPP-MP-5404 - Str. (1) Male BPP 30° (2) Male NPT Pipe</p> |
|  <p>BPP-MP-5405 - Str. (1) Male NPT Pipe (2) Fem. BPP (Rigid)</p> |  <p>BPP-MP-5500 - 90° (1) Male BPP 30° (2) Male NPT Pipe</p> |  <p>BPP-OFS-2404 - Str. (1) Male O-Ring Face Seal (SAE) (2) Male BPP 30°</p> |  <p>BPP-OFS-6400-EO - Str. (1) Male O-Ring Face Seal (SAE) (2) Male BPP w/ Peflex Seal</p> |  <p>BPP-OFS-6400-WO - Str. (1) Male O-Ring Face Seal (SAE) (2) Male BPP w/Washer & O-Ring</p> |  <p>BPP-OFS-6400-L-WO - Str. (1) Male O-Ring Face Seal - Long (SAE) (2) Male BPP w/Washer & O-Ring</p> |
|  <p>BPP-OFS-6801-NWO - Str. (1) Male O-Ring Face Seal (SAE) (2) Male BPP Adj. O-Ring w/ Retainer Washer</p> |  <p>BPP-OFS-6802-NWO - 45° (1) Male O-Ring Face Seal (SAE) (2) Male BPP Adj. O-Ring w/ Retainer Washer</p> |  <p>BPP-OFS-6803-NWO - Tee (1) (2) Male O-Ring Face Seal (SAE) (3) Male BPP Adj. O-Ring w/ Retainer Washer</p> |  <p>BPP-OFS-6804-NWO - Tee (1) (3) Male O-Ring Face Seal (SAE) (2) Male BPP Adj. O-Ring w/ Retainer Washer</p> |  <p>BPP-SPO-2272 - Str. (1) Steel Push On (2) Male BPP</p> |  <p>BPP-SPO-2278 - Str. (1) Steel Push On (2) Fem. BPP Swivel</p> |
|  <p>BPP-SPO-2305 - 45° (1) Steel Push On (2) Fem. BPP (30° Cone) Bent Tube Swivel</p> |  <p>BPP-SPO-2306 - 90° (1) Steel Push On (2) Fem. BPP (30° Cone) Bent Tube Swivel</p> |  <p>BPPOFS-MJ-6510 - Str. (1) Male 37° (2) Fem. BPP O-Ring Face Seal Swivel</p> | | | |

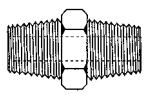
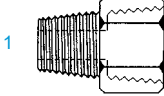
BRITISH STANDARD TAPER

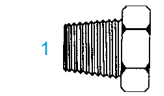
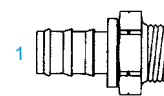
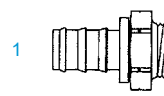
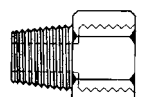
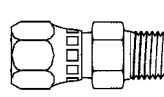
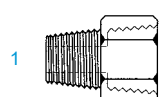
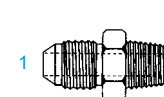
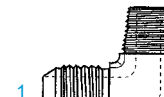
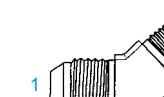
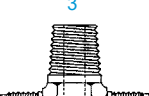
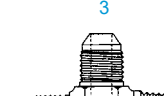
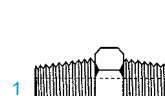
| | | | | | |
|---|---|--|---|---|---|
|  <p>BST-5404 - Str. (1)(2) Male BSPT</p> |  <p>BST-5406 - Str. (1) Male BSPT (2) Fem. BSPT</p> |  <p>BST-5406-HHP (1) BSPT Hollow Hex Plug</p> |  <p>BST-5406-P (1) Male BSPT Plug</p> |  <p>BST-BPO-2272 - Str. (1) Brass Push On (2) Male BSPT</p> |  <p>BST-SPO-2272 - Str. (1) Steel Push On (2) Male BSPT</p> |
|  <p>BST-FBPP-5405 - Str. (1) Male BSPT (2) Fem. BPP</p> |  <p>BST-FJX-6505 - Str. (1) Fem. 37° Swivel (2) Male BSPT</p> |  <p>BST-FP-5405 - Str. (1) Male BSPT (2) Fem. NPT Pipe</p> |  <p>BST-MJ-2404 - Str. (1) Male 37° (2) Male BSPT</p> |  <p>BST-MJ-2501 - 90° (1) Male 37° (2) Male BSPT</p> |  <p>BST-MJ-2503 - 45° (1) Male 37° (2) Male BSPT</p> |
|  <p>BST-MJ-2601 - Tee (1)(2) Male 37° (3) Male BSPT</p> |  <p>BST-MJ-2605 - Tee (1)(3) Male 37° (2) Male BSPT</p> |  <p>BST-MP-5404 - Str. (1) Male BSPT (2) Male NPT Pipe</p> | | | |

JAPANESE INDUSTRIAL STANDARD

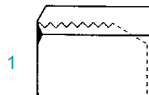
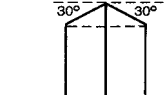
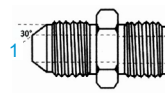
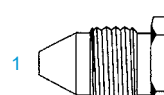
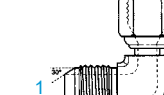
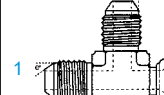
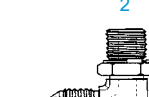
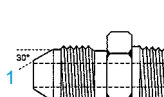
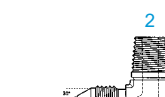
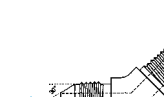
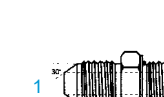
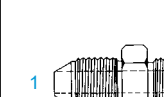
| | | | | | |
|--|---|---|---|---|--|
|  <p>JISBP-0304-C (1) Fem. 30° BPP (Flare) Cap</p> |  <p>JISBP-0321 JIS Sealing Seat (Converts Male 30° BPP Coneseat To 30° JIS Flare)</p> |  <p>JISBP-2403 - Str. (1)(2) Male 30° BPP (Flare)</p> |  <p>JISBP-2408 (1) Male 30° BPP (Flare) Plug</p> |  <p>JISBP-6500 - 90° (1) Male 30° BPP (Flare) (2) Fem. 30° BPP (Flare) Swivel</p> |  <p>JISBP-6602 - Tee (1)(3) Male 30° BPP (Flare) (2) Fem. 30° BPP (Flare) Swivel</p> |
|  <p>JISBP-BPP-6801-NWO - 90° (1) Male 30° BPP (Flare) (2) Male BPP Adj. O-Ring</p> |  <p>JISBP-BST-2404 - Str. (1) Male 30° BPP (Flare) (2) Male BSPT</p> |  <p>JISBP-BST-2501 - 90° (1) Male 30° BPP (Flare) (2) Male BSPT</p> |  <p>JISBP-BST-2503 - 45° (1) Male 30° BPP (Flare) (2) Male BSPT</p> |  <p>JISBP-MB-6400-O - Str. (1) Male 30° BPP (Flare) (2) Male O-Ring (SAE)</p> |  <p>JISBP-MJ-2403 - Str. (1) Male 30° BPP (Flare) (2) Male 37°</p> |





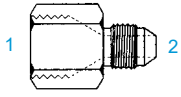
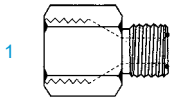
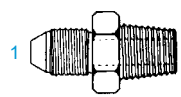
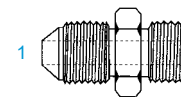
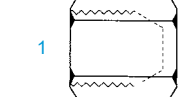
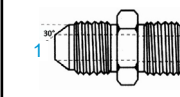
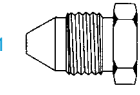
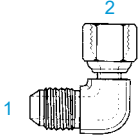
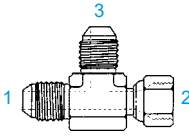
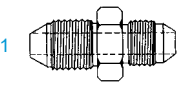
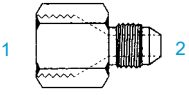
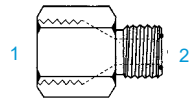
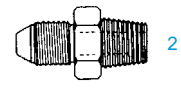
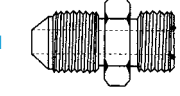

INTERNATIONAL

JAPANESE INDUSTRIAL STANDARD

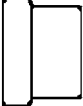



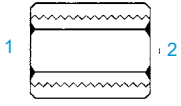
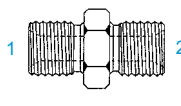

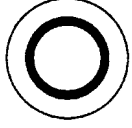
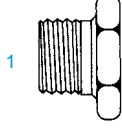
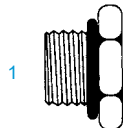
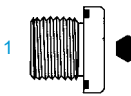
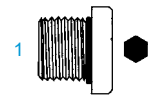



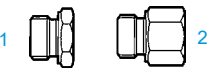
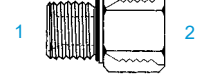
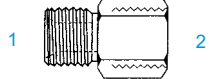
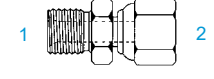
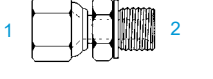
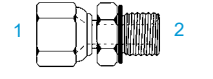
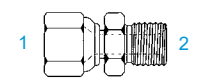
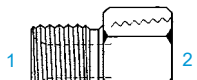
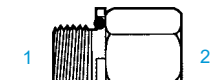
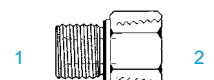
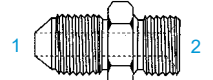

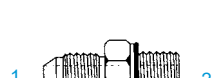
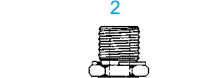



All JISM - Komatsu 1.5mm thread

| | | | | | |
|---|--|---|---|--|---|
|  <p>JISBP-MJ-2406 - Str. (1) Fem. 30° BPP (Flare) (2) Male 37°</p> |  <p>JISBP-MOFS-2406 - Str. (1) Fem. 30° BPP (Flare) (2) Male O-Ring Face Seal(SAE)</p> |  <p>JISBP-MP-2404 - Str. (1) Male 30° BPP (Flare) (2) Male NPT Pipe</p> |  <p>JISBP-OFS-2403 - Str. (1) Male 30° BPP (Flare) (2) Male O-Ring Face Seal(SAE)</p> |  <p>JISM-0304-C (1) Fem. 30° Metric Cap Komatsu</p> |  <p>JISM-2403 - Str. (1)(2) Male 30° Metric Komatsu Union</p> |
|  <p>JISM-2408 (1) Male 30° Metric Komatsu Plug</p> |  <p>JISM-6500 - 90° (1) Male 30° Metric Komatsu (2) Fem. 30° Metric Komatsu Swivel</p> |  <p>JISM-6602 - Tee (1)(3) Male 30° Metric Komatsu (2) Fem. 30° Metric Komatsu Swivel</p> |  <p>JISM-MJ-2403 - Str. (1) Male 30° Metric Komatsu (2) Male 37°</p> |  <p>JISM-MJ-2406 - Str. (1) Fem. 30° Metric Komatsu (2) Male 37°</p> |  <p>JISM-MOFS-2406 - Str. (1) Fem. 30° Metric Komatsu (2) Male O-Ring Face Seal (SAE)</p> |
|  <p>JISM-MP-2404 - Str. (1) Male 30° Metric Komatsu (2) Male NPT Pipe</p> |  <p>JISM-OFS-2403 - Str. (1) Male 30° Metric Komatsu (2) Male O-Ring Face Seal (SAE)</p> | | | | |

METRIC

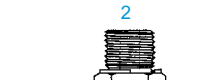









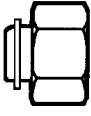



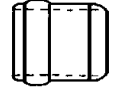
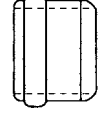
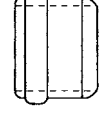

| | | | | | |
|--|---|---|--|---|---|
|  <p>M-0319 37° Tube Sleeve (SAE) for Metric Tubing</p> |  <p>M-4000 Metric Buna-N 90 Duro O-Ring (for use w/ M-6000)</p> |  <p>M-4000-EO Metric Pexflex Seal</p> |  <p>M-4000-ISO Metric ISO O-Ring (6149)</p> |  <p>M-5000 - Str. (1)(2) Fem. Metric(Rigid,Parallel)</p> |  <p>M-5404 - Str. (1)(2) Male Metric (Parallel)</p> |
|  <p>M-6000 Metric Steel Retaining Ring (use w/ M-4000)</p> |  <p>M-6001 Metric Bonded Seal</p> |  <p>M-6408 - Str. (1) Metric Hex Plug (Parallel, use w/ M-6001)</p> |  <p>M-6408-ISO - Str. (1) Metric Hex Plug (Parallel) w/ ISO O-Ring</p> |  <p>M-6408-HHP-EO - Str. (1) Metric Countersunk Hollow Hex Plug w/ Pexflex Seal</p> |  <p>M-6408-HHP-ISO - Str. (1) Metric Countersunk Hollow Hex Plug w/ ISO O-Ring 6149</p> |

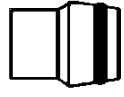
METRIC



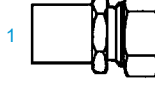
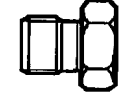
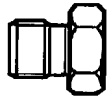
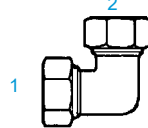
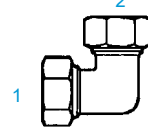
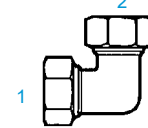
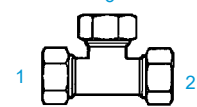

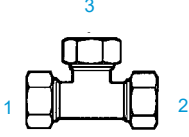
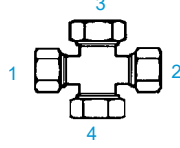
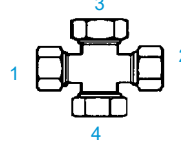
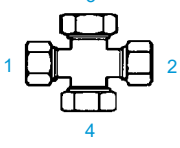
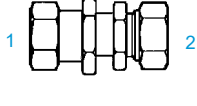
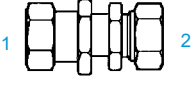
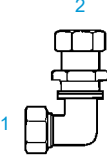
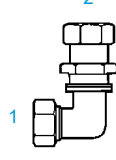
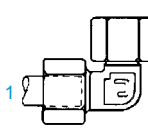
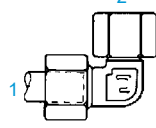
| | | | | | |
|--|--|---|---|--|---|
|  <p>M-6410 - Str. (1) Male Metric (Parallel) (2) Fem. Metric (Parallel) (Length of Hex may vary)</p> |  <p>M-FB-6410-WO - Str. (1) Male Metric w/ Washer O-Ring (2) Fem. O-Ring (SAE)</p> |  <p>M-FBPP-5405 - Str. (1) Male Metric (Parallel) (2) Fem. BPP (Rigid)</p> |  <p>M-FBPP-6510 - Str. (1) Male Metric (Parallel) (2) Fem. BPP Pipe Swivel</p> |  <p>M-FJX-6402-DS - Str. (1) Fem. 37° Swivel (2) Male Metric w/ Dowty Seal (Parallel)</p> |  <p>M-FJX-6402-WO - Str. (1) Fem. 37° Swivel (2) Male Metric w/ Washer & O-Ring (Parallel)</p> |
|  <p>M-FJX-6505 - Str. (1) Fem. 37° Swivel (2) Male Metric (Parallel)</p> |  <p>M-FP-5405 - Str. (1) Male Metric (Parallel) (2) Fem. NPT Pipe</p> |  <p>M-FP-6405-DS - Str. (1) Male Metric w/ Bonded Seal (2) Fem. NPT Pipe</p> |  <p>M-FP-6405-WO - Str. (1) Male Metric w/ Washer & O-Ring (2) Fem. NPT Pipe</p> |  <p>M-MJ-2404 - Str. (1) Male 37° (2) Male Metric (Parallel) (some w/ 30°, some w/ 24° seat)</p> |  <p>M-MJ-6400-DS - Str. (1) Male 37° (2) Male Metric w/ Bonded Seal</p> |
|  <p>M-MJ-6400-WO - Str. (1) Male 37° (2) Male Metric w/ Washer & O-Ring</p> |  <p>M-MJ-6801-NWO - 90° (1) Male 37° (2) Male Metric Adj. w/ Washer & O-Ring</p> |  <p>M-MJ-6801-L-NWO - 90° (1) Male 37° (2) Male Metric Adj. w/ Washer & O-Ring - Long</p> |  <p>M-MJ-6802-NWO - 45° (1) Male 37° (2) Male Metric Adj. w/ Washer & O-Ring</p> |  <p>M-MJ-6803-NWO - Tee (1)(2) Male 37° (3) Male Metric Adj. w/ Washer & O-Ring</p> |  <p>M-MJ-6804-NWO - Tee (1)(3) Male 37° (2) Male Metric Adj. w/ Washer & O-Ring</p> |
|  <p>M-MP-5405 - Str. (1) Male NPT Pipe (2) Fem. Metric (Parallel)</p> |  <p>M-OFS-6400-EO - Str. (1) Male O-Ring Face Seal (SAE) (2) Male Metric w/ Peflex Seal</p> |  <p>M-OFS-6400-WO - Str. (1) Male O-Ring Face Seal (SAE) (2) Male Metric w/ Washer & O-Ring</p> |  <p>M-OFS-6400-L-WO - Str. (1) Male O-Ring Face Seal (SAE) (2) Male Metric w/ Washer & O-Ring - Long</p> |  <p>M-OFS-6801-NWO - 90° (1) Male O-Ring Face Seal (SAE) (2) Male Metric Adj. w/ Washer O-Ring</p> |  <p>M-OFS-6801-NWO-ISO - 90° (1) Male O-Ring Face Seal (SAE) (2) Male Metric Adj. w/ Washer ISO O-Ring 6149</p> |
|  <p>M-OFS-6802-NWO-ISO - 45° (1) Male O-Ring Face Seal (SAE) (2) Male Metric Adj. w/ Washer ISO O-Ring 6149</p> |  <p>M-OFS-6803-NWO-ISO - Tee (1)(2) Male O-Ring Face Seal (SAE) (3) Male Metric Adj. w/ Washer ISO O-Ring 6149</p> |  <p>M-OFS-6804-NWO - Tee (1)(3) Male O-Ring Face Seal (SAE) (2) Male Metric Adj. w/ Washer O-Ring</p> |  <p>M-SBT-2404 - Str. (1) Male 37° (2) Metric O-Ring Bump Tube Port Adapter</p> | | |

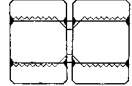
INTERNATIONAL

METRIC FLARELESS

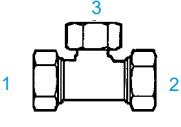
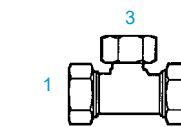
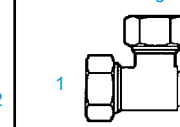
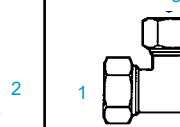
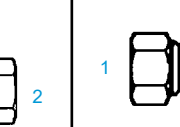
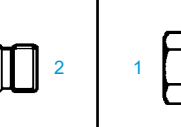
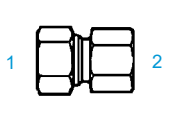
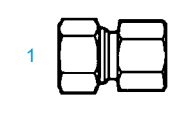
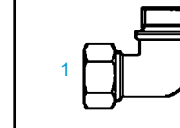
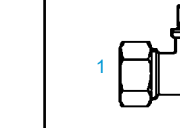
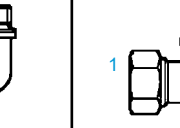

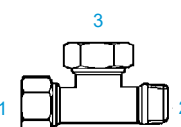
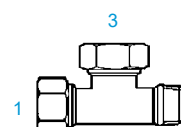
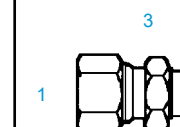
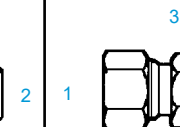
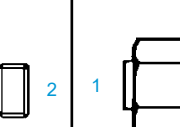
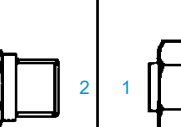
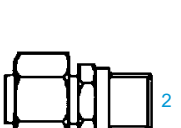
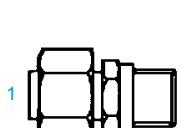
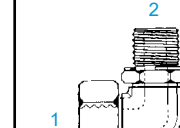
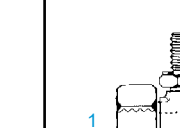
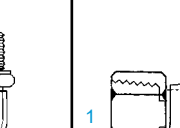
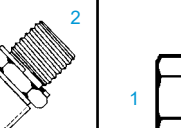
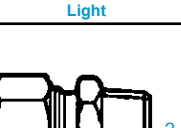
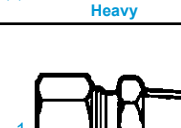
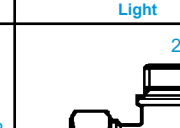
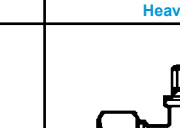
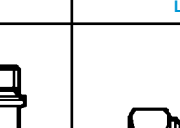

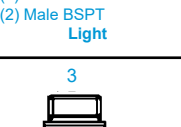
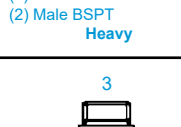
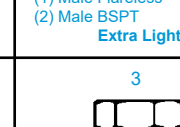
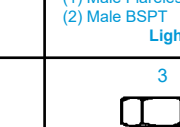
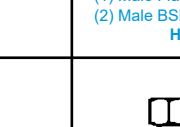
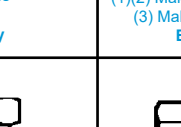

| | | | | | |
|--|--|---|---|---|---|
|  <p>MFL-0304-C Cap Nut Light</p> |  <p>MFL-0304-C-H Cap Nut Heavy</p> |  <p>MFL-0306 Bulkhead Lock Nut Light</p> |  <p>MFL-0306-H Bulkhead Lock Nut Heavy</p> |  <p>MFL-0318-LL Flareless Nut Extra Light</p> |  <p>MFL-0318 Flareless Nut Light</p> |
|  <p>MFL-0318-H Flareless Nut Heavy</p> |  <p>MFL-0319-LL Flareless Sleeve Extra Light</p> |  <p>MFL-0319 Flareless Sleeve Light</p> |  <p>MFL-0319-H Flareless Sleeve Heavy</p> |  <p>MFL-0320 Blanking Plug w/ O-Ring Light</p> |  <p>MFL-0320-H Blanking Plug w/ O-Ring Heavy</p> |
|  <p>MFL-2403-LL - Str. (1)(2) Male Flareless Union Extra Light</p> |  <p>MFL-2403 - Str. (1)(2) Male Flareless Union Light</p> |  <p>MFL-2403-H - Str. (1)(2) Male Flareless Union Heavy</p> |  <p>MFL-2406 - Str. - Reducer (1) Metric Standpipe (2) Male Flareless Light</p> |  <p>MFL-2406-H - Str. - Reducer (1) Metric Standpipe (2) Male Flareless Heavy</p> |  <p>MFL-2408 - Str. (1) Male Flareless Plug Light</p> |
|  <p>MFL-2408-H - Str. (1) Male Flareless Plug Heavy</p> |  <p>MFL-2500-LL - 90° (1)(2) Male Flareless Extra Light</p> |  <p>MFL-2500 - 90° (1)(2) Male Flareless Light</p> |  <p>MFL-2500-H - 90° (1)(2) Male Flareless Heavy</p> |  <p>MFL-2603-LL-Tee (1)(2)(3) Male Flareless Extra Light</p> |  <p>MFL-2603-Tee (1)(2)(3) Male Flareless Light</p> |
|  <p>MFL-2603-H-Tee (1)(2)(3) Male Flareless Heavy</p> |  <p>MFL-2650-LL - Cross (1)(2)(3)(4) Male Flareless Extra Light</p> |  <p>MFL-2650 - Cross (1)(2)(3)(4) Male Flareless Light</p> |  <p>MFL-2650-H - Cross (1)(2)(3)(4) Male Flareless Heavy</p> |  <p>MFL-2700-LN - Str. (1) Male Flareless (2) Male Flareless Bulkhead w/ Lock Nut Light</p> |  <p>MFL-2700-H-LN - Str. (1) Male Flareless (2) Male Flareless Bulkhead w/ Lock Nut Heavy</p> |
|  <p>MFL-2701-LN - 90° (1) Male Flareless (2) Male Flareless Bulkhead w/ Lock Nut Light</p> |  <p>MFL-2701-H-LN - 90° (1) Male Flareless (2) Male Flareless Bulkhead w/ Lock Nut Heavy</p> |  <p>MFL-6500 - 90° (1) Male Flareless (2) Fem. Flareless Swivel Light</p> |  <p>MFL-6500-H - 90° (1) Male Flareless (2) Fem. Flareless Swivel Heavy</p> |  <p>MFL-6565 - Str. (1)(2) Fem. Flareless Swivel Light</p> |  <p>MFL-6565-H - Str. (1)(2) Fem. Flareless Swivel Heavy</p> |

METRIC FLARELESS

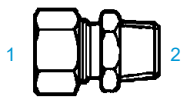
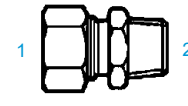
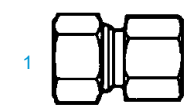
| | | | | | |
|--|--|---|---|--|---|
|  <p>MFL-6600 - Tee (1)(2) Male Flareless (3) Fem. Flareless Swivel Light</p> |  <p>MFL-6600-H - Tee (1)(2) Male Flareless (3) Fem. Flareless Swivel Heavy</p> |  <p>MFL-6602 - Tee (1)(3) Male Flareless (2) Fem. Flareless Swivel Light</p> |  <p>MFL-6602-H - Tee (1)(3) Male Flareless (2) Fem. Flareless Swivel Heavy</p> |  <p>MFL-BPP-2404 - Str. (1) Male Flareless (2) Male BPP w/ Cutting Face Seal Light</p> |  <p>MFL-BPP-2404-H - Str. (1) Male Flareless (2) Male BPP w/ Cutting Face Seal Heavy</p> |
|  <p>MFL-BPP-2405 - Str. (1) Male Flareless (2) Fem. BPP - Rigid Light</p> |  <p>MFL-BPP-2405-H - Str. (1) Male Flareless (2) Fem. BPP - Rigid Heavy</p> |  <p>MFL-BPP-2501 - 90° (1) Male Flareless (2) Male BPP w/ Cutting Face Seal Light</p> |  <p>MFL-BPP-2501-H - 90° (1) Male Flareless (2) Male BPP w/ Cutting Face Seal Heavy</p> |  <p>MFL-BPP-2601 - Tee (1) Male Flareless (2) Male BPP w/ Cutting Face Seal Light</p> |  <p>MFL-BPP-2601-H - Tee (1) Male Flareless (2) Male BPP w/ Cutting Face Seal Heavy</p> |
|  <p>MFL-BPP-2605 - Tee (1)(3) Male Flareless (2) Male BPP w/ Cutting Face Seal Light</p> |  <p>MFL-BPP-2605-H - Tee (1)(3) Male Flareless (2) Male BPP w/ Cutting Face Seal Heavy</p> |  <p>MFL-BPP-6400-EO - Str. (1) Male Flareless (2) Male BPP w/ Peflex Seal Light</p> |  <p>MFL-BPP-6400-H-EO - Str. (1) Male Flareless (2) Male BPP w/ Peflex Seal Heavy</p> |  <p>MFL-BPP-6510 - Str. (1) Fem. Flareless Swivel (2) Male BPP w/ Cutting Face Seal Light</p> |  <p>MFL-BPP-6510-H - Str. (1) Fem. Flareless Swivel (2) Male BPP w/ Cutting Face Seal Heavy</p> |
|  <p>MFL-BPP-6510-EO - Str. (1) Fem. Flareless Swivel (2) Male BPP - w/ Peflex Seal Light</p> |  <p>MFL-BPP-6510-H-EO - Str. (1) Fem. Flareless Swivel (2) Male BPP - w/ Peflex Seal Heavy</p> |  <p>MFL-BPP-6801-NWO - 90° (1) Male Flareless (2) Male BPP w/ Washer O-Ring Light</p> |  <p>MFL-BPP-6801-H-NWO - 90° (1) Male Flareless (2) Male BPP w/ Washer O-Ring Heavy</p> |  <p>MFL-BPP-6810-NWO - 45° (1) Male Flareless (2) Male BPP w/ Washer O-Ring Light</p> |  <p>MFL-BST-2404-LL - Str. (1) Male Flareless (2) Male BSPT Extra Light</p> |
|  <p>MFL-BST-2404 - Str. (1) Male Flareless (2) Male BSPT Light</p> |  <p>MFL-BST-2404-H - Str. (1) Male Flareless (2) Male BSPT Heavy</p> |  <p>MFL-BST-2501-LL - 90° (1) Male Flareless (2) Male BSPT Extra Light</p> |  <p>MFL-BST-2501-LL - 90° (1) Male Flareless (2) Male BSPT Light</p> |  <p>MFL-BST-2501-H - 90° (1) Male Flareless (2) Male BSPT Heavy</p> |  <p>MFL-BST-2601-LL - Tee (1)(2) Male Flareless (3) Male BSPT Extra Light</p> |
|  <p>MFL-BST-2601 - Tee (1)(2) Male Flareless (3) Male BSPT Light</p> |  <p>MFL-BST-2601-H - Tee (1)(2) Male Flareless (3) Male BSPT Heavy</p> |  <p>MFL-BST-2605-LL - Tee (1)(3) Male Flareless (2) Male BSPT Extra Light</p> |  <p>MFL-BST-2605 - Tee (1)(3) Male Flareless (2) Male BSPT Light</p> |  <p>MFL-BST-2605-H - Tee (1)(3) Male Flareless (2) Male BSPT Heavy</p> |  <p>MFL-M-2404-LL - Str. (1) Male Flareless (2) Male Metric Parallel w/ Cutting Face Seal Extra Light</p> |

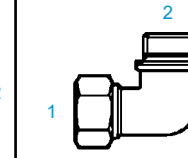
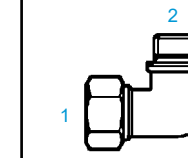
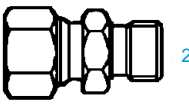
INTERNATIONAL

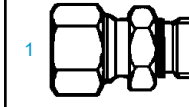
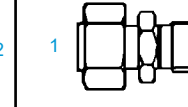
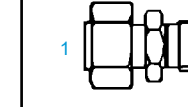
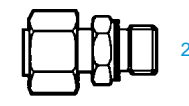
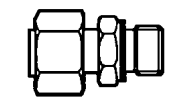
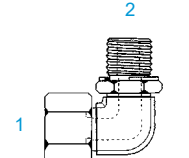
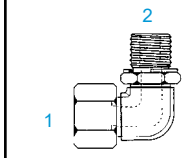
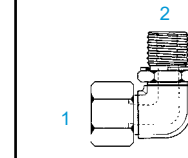
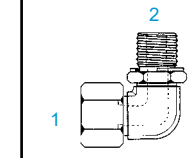
METRIC FLARELESS

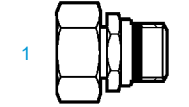
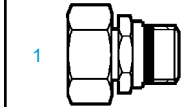
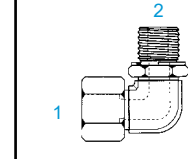
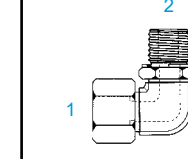
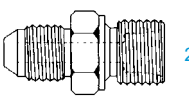
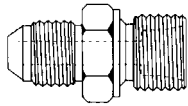
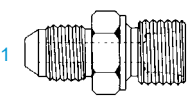
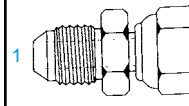
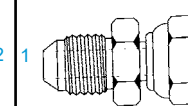
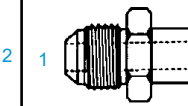
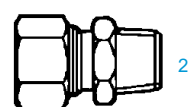
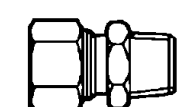
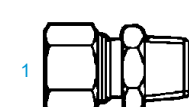
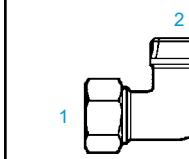
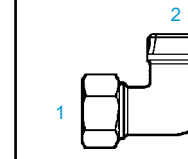
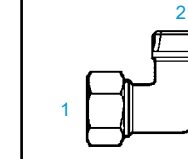
| | | | | | |
|---|---|--|--|--|--|
|  <p>MFL-M-2404 - Str. (1) Male Flareless (2) Male Metric Parallel w/ Cutting Face Seal Light</p> |  <p>MFL-M-2404-H - Str. (1) Male Flareless (2) Male Metric Parallel w/ Cutting Face Seal Heavy</p> |  <p>MFL-M-2405 - Str. (1) Male Flareless (2) Fem. Metric Parallel-Rigid Light</p> |  <p>MFL-M-2405-H - Str. (1) Male Flareless (2) Fem. Metric Parallel-Rigid Heavy</p> |  <p>MFL-M-2501 - 90° (1) Male Flareless (2) Male Metric Parallel w/ Cutting Face Seal Light</p> |  <p>MFL-M-2501-H - 90° (1) Male Flareless (2) Male Metric Parallel w/ Cutting Face Seal Heavy</p> |
|  <p>MFL-M-6400-EO - Str. (1) Male Flareless (2) Male Metric w/ Peflex Seal Light</p> |  <p>MFL-M-6400-H-EO - Str. (1) Male Flareless (2) Male Metric w/ Peflex Seal Heavy</p> |  <p>MFL-M-6400-ISO - Str. (1) Male Flareless (2) Male Metric w/ ISO O-Ring 6149 Light</p> |  <p>MFL-M-6400-H-ISO - Str. (1) Male Flareless (2) Male Metric w/ ISO O-Ring 6149 Heavy</p> |  <p>MFL-M-6510 - Str. (1) Fem. Flareless Swivel (2) Male Metric Parallel w/ Cutting Face Seal Light</p> |  <p>MFL-M-6510-H - Str. (1) Fem. Flareless Swivel (2) Male Metric Parallel w/ Cutting Face Seal Heavy</p> |
|  <p>MFL-M-6510-EO - Str. (1) Fem. Flareless Swivel (2) Male Metric Parallel w/ Peflex Seal Light</p> |  <p>MFL-M-6510-H-EO - Str. (1) Fem. Flareless Swivel (2) Male Metric Parallel w/ Peflex Seal Heavy</p> |  <p>MFL-M-6801-NWO - 90° (1) Male Flareless (2) Male Metric w/ Washer O-Ring Light</p> |  <p>MFL-M-6801-H-NWO - 90° (1) Male Flareless (2) Male Metric w/ Washer O-Ring Heavy</p> |  <p>MFL-M-6801-NWO-ISO - 90° (1) Male Flareless (2) Male Metric w/ ISO O-Ring 6149 Light</p> |  <p>MFL-M-6801-H-NWO-ISO - 90° (1) Male Flareless (2) Male Metric w/ ISO O-Ring 6149 Heavy</p> |
|  <p>MFL-MB-6400-O - Str. (1) Male Flareless (2) Male O-Ring Boss Light</p> |  <p>MFL-MB-6400-H-O - Str. (1) Male Flareless (2) Male O-Ring Boss Heavy</p> |  <p>MFL-MB-6510-O - Str. (1) Fem. Flareless Swivel (2) Male O-Ring Boss Light</p> |  <p>MFL-MB-6510-H-O - Str. (1) Fem. Flareless Swivel (2) Male O-Ring Boss Heavy</p> |  <p>MFL-MB-6801-NWO - 90° (1) Male Flareless (2) Male O-Ring Boss Light</p> |  <p>MFL-MB-6801-H-NWO - 90° (1) Male Flareless (2) Male O-Ring Boss Heavy</p> |
|  <p>MFL-MJ-3901-LL - Str. (1) Male 37° (2) Male Metric Dual Purpose (Port or Tube) Extra Light</p> |  <p>MFL-MJ-3901 - Str. (1) Male 37° (2) Male Metric Dual Purpose (Port or Tube) Light</p> |  <p>MFL-MJ-3901-H - Str. (1) Male 37° (2) Male Metric Dual Purpose (Port or Tube) Heavy</p> |  <p>MFL-MJ-6510 - Str. (1) Male 37° (2) Fem. Flareless Swivel Light</p> |  <p>MFL-MJ-6510-H - Str. (1) Male 37° (2) Fem. Flareless Swivel Heavy</p> |  <p>MFL-MJ-6511 - Str. (1) Male 37° (2) Metric Standpipe Light</p> |
|  <p>MFL-MP-2404-LL - Str. (1) Male Flareless (2) Male NPT Extra Light</p> |  <p>MFL-MP-2404 - Str. (1) Male Flareless (2) Male NPT Light</p> |  <p>MFL-MP-2404-H - Str. (1) Male Flareless (2) Male NPT Heavy</p> |  <p>MFL-MP-2501-LL - 90° (1) Male Flareless (2) Male NPT Extra Light</p> |  <p>MFL-MP-2501 - 90° (1) Male Flareless (2) Male NPT Light</p> |  <p>MFL-MP-2501-H - 90° (1) Male Flareless (2) Male NPT Heavy</p> |

METRIC FLARELESS

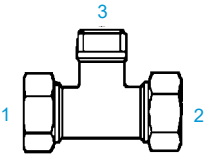
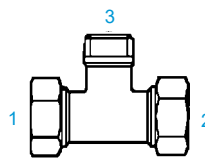
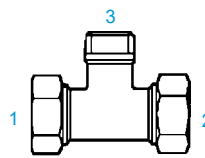
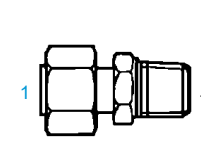
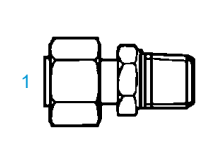
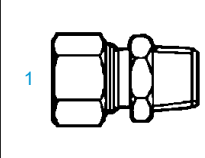
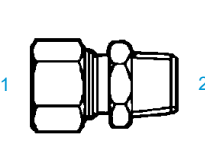
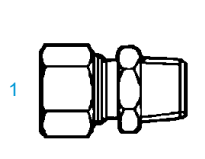
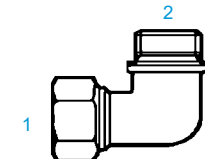
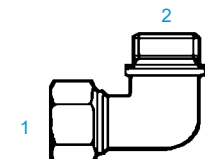
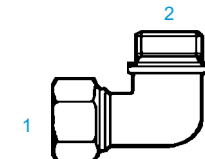
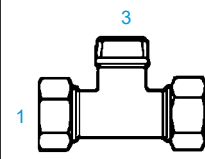
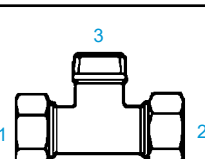
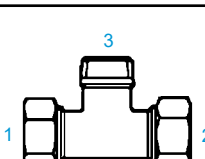
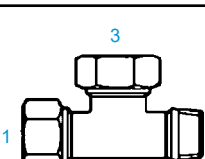
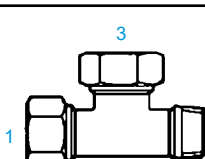
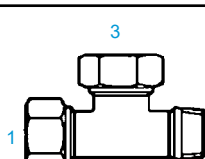
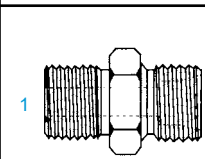
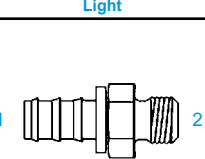
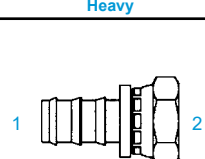
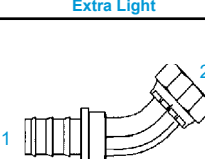
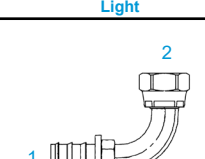
| | | | | | |
|--|---|--|--|---|---|
|  <p>MFL-MP-2601-LL - Tee (1)(2) Male Flareless (3) Male NPT Extra Light</p> |  <p>MFL-MP-2601 - Tee (1)(2) Male Flareless (3) Male NPT Light</p> |  <p>MFL-MP-2601-H - Tee (1)(2) Male Flareless (3) Male NPT Heavy</p> |  <p>MFL-MP-6510 - Str. (1) Fem. Flareless Swivel (2) Male NPT Light</p> |  <p>MFL-MP-6510-H - Str. (1) Fem. Flareless Swivel (2) Male NPT Heavy</p> |  <p>MFL-MT-2404-LL - Str. (1) Male Flareless (2) Male Metric Taper Extra Light</p> |
|  <p>MFL-MT-2404 - Str. (1) Male Flareless (2) Male Metric Taper Light</p> |  <p>MFL-MT-2404-H - Str. (1) Male Flareless (2) Male Metric Taper Heavy</p> |  <p>MFL-MT-2501-LL - 90° (1) Male Flareless (2) Male Metric Taper Extra Light</p> |  <p>MFL-MT-2501 - 90° (1) Male Flareless (2) Male Metric Taper Light</p> |  <p>MFL-MT-2501-H - 90° (1) Male Flareless (2) Male Metric Taper Heavy</p> |  <p>MFL-MT-2601-LL - Tee (1)(2) Male Flareless (3) Male Metric Taper Extra Light</p> |
|  <p>MFL-MT-2601 - Tee (1)(2) Male Flareless (3) Male Metric Taper Light</p> |  <p>MFL-MT-2601-H - Tee (1)(2) Male Flareless (3) Male Metric Taper Heavy</p> |  <p>MFL-MT-2605-LL - Tee (1)(3) Male Flareless (2) Male Metric Taper Extra Light</p> |  <p>MFL-MT-2605 - Tee (1)(3) Male Flareless (2) Male Metric Taper Light</p> |  <p>MFL-MT-2605-H - Tee (1)(3) Male Flareless (2) Male Metric Taper Heavy</p> |  <p>MFL-OFS-3901 - Str. (1) Male O-Ring Face Seal (2) Male Metric Dual Purpose (Port or Tube)</p> |
|  <p>MFL-SPO-2272 - Str. (1) Male Push On (2) Male Metric 24°</p> |  <p>MFL-SPO-2278 - Str. (1) Male Push On (2) Fem. Metric 24° Swivel</p> |  <p>MFL-SPO-2305 - 45° (1) Male Push On (2) Fem. Metric 24° Swivel</p> |  <p>MFL-SPO-2306 - 90° (1) Male Push On (2) Fem. Metric 24° Swivel</p> | | |

MISCELLANEOUS

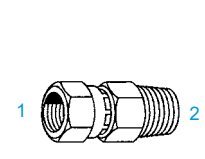
| | | | | | |
|---|--|--|--|--|--|
|  <p>MT-FJX-6505 - Str. (1) Fem. 37° Swivel (2) Male Metric Taper</p> | | | | | |
|---|--|--|--|--|--|

INTERNATIONAL

THREAD IDENTIFICATION KIT



Thread Identification Kit for male and female threads includes:

- 1/8-28 BSP through 2-11 BSP thread gauges
- M8 x 1.0 through M52 x 2.0 metric thread gauges
- Thread and Port Guide

This kit includes carrying case and 31 dual threaded gauges that allow you to identify BSP and Metric threads quickly. Fittings Unlimited, Inc. also carries optional Digital Calipers.

Metric ID kit 31 pieces and box

IDENTIFYING METRIC CONNECTIONS

GERMAN DIN COMPRESSION

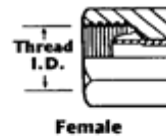
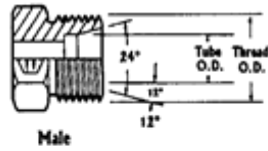

| Series | Oper. Press. (bar) | Tube O.D. | Thread Size |
|--------|--------------------|-----------|-------------|
| LL | 100 | 4 | M 8x1 |
| LL | 100 | 6 | M 10x1 |
| LL | 100 | 8 | M 12x1 |
| L | 250 | 6 | M 12x1.5 |
| L | 250 | 8 | M 14x1.5 |
| L | 250 | 10 | M 16x1.5 |
| L | 250 | 12 | M 18x1.5 |
| L | 250 | 15 | M 22x1.5 |
| L | 160 | 18 | M 26x1.5 |
| L | 160 | 22 | M 30x2 |
| L | 100 | 28 | M 36x2 |
| L | 100 | 35 | M 45x2 |
| L | 100 | 42 | M 52x2 |
| S | 630 | 6 | M 14x1.5 |
| S | 630 | 8 | M 16x1.5 |
| S | 630 | 10 | M 18x1.5 |
| S | 630 | 12 | M 20x1.5 |
| S | 630 | 14 | M 22x1.5 |
| S | 400 | 16 | M 24x1.5 |
| S | 400 | 20 | M 30x2 |
| S | 400 | 25 | M 36x2 |
| S | 250 | 30 | M 42x2 |
| S | 250 | 38 | M 52x2 |

| Tube O.D. Light MM | Tube O.D. Heavy MM | Metric Thread Size | Male Thread O.D. | | Female Thread I.D. | |
|--------------------|--------------------|--------------------|------------------|-------------|--------------------|-------------|
| | | | MM | Frac. (in.) | MM | Frac. (in.) |
| 6 | | M12x1.5 | 12 | 15/32 | 10.5 | 13/32 |
| 8 | 6 | M14x1.5 | 14 | 9/16 | 12.5 | 1/2 |
| 10 | 8 | M16x1.5 | 16 | 5/8 | 14.5 | 9/16 |
| 12 | 10 | M18x1.5 | 18 | 23/32 | 16.5 | 21/32 |
| | 12 | M20x1.5 | 20 | 25/32 | 18.5 | 23/32 |
| 15 | 14 | M22x1.5 | 22 | 7/8 | 20.5 | 13/16 |
| | 16 | M24x1.5 | 24 | 15/16 | 22.5 | 7/8 |
| 18 | | M26x1.5 | 26 | 1-1/32 | 24.5 | 31/32 |
| 22 | 20 | M30x2.0 | 30 | 1-3/16 | 28 | 1-1/8 |
| 28 | 25 | M36x2.0 | 36 | 1-13/32 | 34 | 1-11/32 |
| | 30 | M42x2.0 | 42 | 1-21/32 | 40 | 1-9/16 |
| 35 | | M45x2.0 | 45 | 1-25/32 | 43 | 1-23/32 |
| 42 | 38 | M52x2.0 | 52 | 2-1/32 | 50 | 1-31/32 |

This connection style consists of a common male and three different female styles.

The male has a straight metric thread, a 24° included angle and a recessed counterbore that matches the tube O.D. used with it. The female may be a tube, nut and sleeve, a globeseal or a globeseal with an O-Ring in the nose.

| Metric Thread Size | Male Thread O.D. (A) (mm) | Female Thread I.D. (B) (mm) |
|--------------------|---------------------------|-----------------------------|
| M 10x1 | 10 | 8.5 |
| M 12x1.5 | 12 | 10.5 |
| M 14x1.5 | 14 | 12.5 |
| M 16x1.5 | 16 | 14.5 |
| M 18x1.5 | 18 | 16.5 |
| M 20x1.5 | 20 | 18.5 |
| M 22x1.5 | 22 | 20.5 |
| M 26x1.5 | 26 | 24.5 |
| M 27x2 | 27 | 25.5 |
| M 30x2 | 30 | 28.5 |
| M 33x2 | 33 | 31.5 |
| M 42x2 | 42 | 39.9 |
| M 48x2 | 48 | 46.5 |
| M 52x2 | 52 | 50.5 |
| M 65x2 | 65 | 62.9 |
| M 78x2 | 78 | 75.9 |
| M 90x2 | 90 | 87.9 |

Common Port Sealing Designs



DIN 3852 Form B: Sealing by means of a sealing "shoulder." Female thread is parallel.

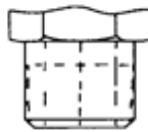

DIN 3852 Form C: Sealing by means of tapered thread. Female thread must be tapered to achieve rated operating pressure.

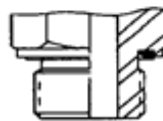

Form PEFLEX: Sealing by means of a profiled elastomer ring recessed into the fitting body. Female thread is parallel.



DIN 3852 Form A (formerly Form D): Sealing by means of a washer or bonded seal. Female thread is parallel.



Form SAE J514: Sealing by means of an O-Ring in the thread undercut. Female thread is parallel.

BRITISH STANDARD PIPE

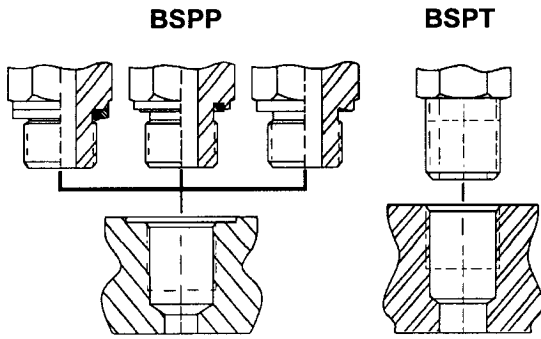

| Dash Size | Inch Size | Thread | Male Thread O.D. | | Female Thread I.D. | |
|-----------|-----------|------------|------------------|------|--------------------|------|
| | | | mm | in | mm | in |
| -2 | 1/8 | 1/8 - 28 | 9.4 | .37 | 8.1 | .32 |
| -4 | 1/4 | 1/4 - 19 | 13.7 | .53 | 12.4 | .49 |
| -6 | 3/8 | 3/8 - 19 | 17.2 | .68 | 16.0 | .62 |
| -8 | 1/2 | 1/2 - 14 | 21.5 | .84 | 19.8 | .77 |
| -10 | 5/8 | 5/8 - 14 | 23.1 | .91 | 20.6 | .81 |
| -12 | 3/4 | 3/4 - 14 | 26.9 | 1.06 | 25.4 | 1.00 |
| -16 | 1 | 1 - 11 | 34.0 | 1.34 | 31.8 | 1.25 |
| -20 | 1 1/4 | 1 1/4 - 11 | 42.6 | 1.68 | 40.4 | 1.59 |
| -24 | 1 1/2 | 1 1/2 - 11 | 48.5 | 1.90 | 46.2 | 1.81 |
| -32 | 2 | 2 | 60.4 | 2.37 | 58.2 | 2.29 |

The BSPT (tapered) connection is similar to the NPT except that the thread pitches are different in most sizes. To achieve full pressure rating, a tapered male must be threaded into a tapered female.

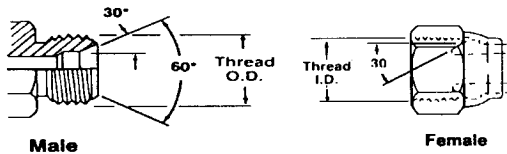

The BSPP (parallel) male is similar to the NPSM male except the thread pitches are different in most sizes. The mating female swivel is a BSP globe seal, which seals on the cone of the male.

JAPANESE

Metric and British JIS 30° Flare

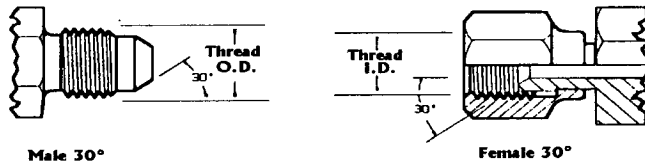

METRIC

| Dash No. | Metric Size Equiv. | Metric Thread | Male Thread O.D. | | Female Thread I.D. | |
|----------|--------------------|---------------|------------------|------|--------------------|------|
| | | | mm | in | mm | in |
| -4 | | M14x1.5 | 14 | .55 | 12.5 | |
| -6 | 9 | M18x1.5 | 18 | .71 | 16.5 | .65 |
| -8 | 12 | M22x1.5 | 22 | .87 | 20.5 | .82 |
| -10 | 16 | M24x1.5 | 24 | .94 | 22.5 | .88 |
| -12 | 19 | M30x1.5 | 30 | 1.18 | 28.5 | 1.12 |
| -16 | 25 | M33x1.5 | 33 | 1.30 | 31.5 | 1.24 |
| -20 | 32 | M36x1.5 | 36 | 1.42 | 34.5 | 1.36 |
| -24 | 38 | M42x1.5 | 42 | 1.65 | 40.5 | 1.59 |

METRIC

Used extensively on Komatsu equipment this 30° flare connector has parallel metric threads and is sometimes confused with JIS 30° flare which has BSPP threads.

BSPP

This Japanese connector is similar to the American 37° JIC flare except for the 30° seat angle. The straight (parallel) threads are the same as BSPP.

BSPP

| Dash Size | Inch Size | Thread | Male Thread O.D. | | Female Thread I.D. | |
|-----------|-----------|------------|------------------|------|--------------------|------|
| | | | mm | in | mm | in |
| -2 | 1/8 | 1/8 - 28 | 9.4 | .37 | 8.1 | .32 |
| -4 | 1/4 | 1/4 - 19 | 13.7 | .53 | 12.4 | .49 |
| -6 | 3/8 | 3/8 - 19 | 17.2 | .68 | 16.0 | .62 |
| -8 | 1/2 | 1/2 - 14 | 21.5 | .84 | 19.8 | .77 |
| -10 | 5/8 | 5/8 - 14 | 23.1 | .91 | 20.6 | .81 |
| -12 | 3/4 | 3/4 - 14 | 26.9 | 1.06 | 25.4 | 1.00 |
| -16 | 1 | 1 - 11 | 34.0 | 1.34 | 31.8 | 1.25 |
| -20 | 1 1/4 | 1 1/4 - 11 | 42.6 | 1.68 | 40.4 | 1.59 |
| -24 | 1 1/2 | 1 1/2 - 11 | 48.5 | 1.90 | 46.2 | 1.81 |
| -32 | 2 | 2 | 60.4 | 2.37 | 58.2 | 2.29 |

Mission Statement

We support the quality of our customers...

We believe in the value of our vendors...

We respect the contributions of our employees...

Since 1985, Fittings Unlimited, Inc. has dedicated itself to service, quality and engineering performance in the distribution of hydraulic fittings and adapters. FUI is your World Class Connection for quality products, service, timely delivery and competitive pricing. Our 55,000 square foot warehouse located in Dallas, Texas and 42,000 additional square feet in Houston, Texas, Cleveland, Ohio, Salt Lake City, Utah and Ontario, Canada allow for superior service throughout North America. We provide customers with a single quality source to purchase multiple product lines thus reducing their vendor base, freight costs and purchasing/accounting costs.

Todd Y. Shallcross
President

Other Stock Items

Aluminum Adapters
Composite Push Connect
Flare O-Ring Fittings
Hydraulic Tubing
Hose Protectors
Quick Connect
Stainless Steel Metric
Steel Live Swivels
Tools



1-800-348-8467

www.myfui.com